

USER MANUAL

CTS602 HMI BY NILAN



VPL15 (English)

Version 3.00 - 19.07.2019

TABLE OF CONTENTS

Safety

Power supply.....	3
Disposal.....	3
Ventilation unit.....	3
Heatpump.....	3

General information

Introduction.....	4
Type plate.....	4

Quick guide

Functions of control panel.....	5
Main screen elements.....	5
Settings options on the main screen.....	6
Warnings and alarms.....	7
Settings menu overview.....	8

Service and maintenance

Maintenance.....	9
Regular maintenance.....	9
External cleaning.....	9
Water trap.....	9
Filter replacement.....	9
Illustration of filter change.....	10
Illustration of filter change in FU15 (accessory).....	11
Service.....	12
Annual service.....	12
Internal cleaning.....	12
Check the air intake and outlet.....	12
Check ventilation ducts.....	12
The heat pump.....	12

User settings

Ventilation settings.....	13
Stop the unit.....	13
Operating function.....	13
Alarm.....	14
Show data.....	14
Date/Time.....	15
Week program.....	16
After-heating.....	18
Cooling.....	19
Air humidity.....	20
CO2.....	21
Air exchange.....	22
Air filter.....	23
Temp. control.....	24
Language.....	24

Alarm list

VPL unit.....	25
Alarm list.....	25

Product data

Declaration of compliance.....	27
--------------------------------	----

Safety

Power supply

**CAUTION**

Always disconnect the power supply to the unit if an error occurs that cannot be rectified via the control panel.

**CAUTION**

If an error occurs on electrically conductive parts of the unit, always contact an authorised electrician to rectify the error.

**CAUTION**

Always disconnect the power supply to the unit before opening the unit doors, for instance for installation, inspection, cleaning and filter change.

Disposal

Ventilation unit



Nilan's units consist mainly of recyclable materials. They must, therefore, not be mixed with household waste, but must be delivered to your local recycling center for disposal.

Heatpump



Concerning disposal of units with heat pumps, it is important to contact the local authorities for information about correct handling of these. The heatpump contains the refrigerant R134a, which is harmful to the environment if not handled correctly.

General information

Introduction



ATTENTION



The unit must be started up immediately after installation and connection to the duct system. When a ventilation unit is not in operation, humidity from the rooms may penetrate into the ducts and create condensation. Condensate water may leak out of the valves and damage furniture and floors. Condensation may also form inside the unit, which can damage its electronics and fans.

The unit is delivered fully tested and ready for operation.

Type plate

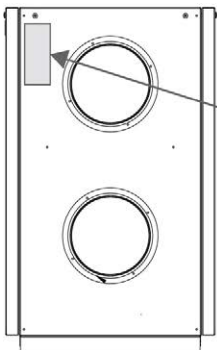
On the right side of the unit you will find the Nilan type plate.



		DK 8722 	
"Name"			
Item no.	: 7111440	Voltage 50Hz	: 230V
Serial no.	: 441105019	Power [kW]	: 0,18
Year built	: 2018	IP - Code	: IP31
SN: 441105019			

Note: Contact Nilan a/s with questions about the product, it is important to have the unit name and serial No. (SN) ready. On the basis of this information, please contact service department find all informations about the relevant aggregate and thus provide information and answer questions about what the aggregate consists of/contains, as well as the software used.

Quick guide

Functions of control panel

Main screen elements

The main screen of the HMI panel contains the settings options and the information that an operator mostly uses.

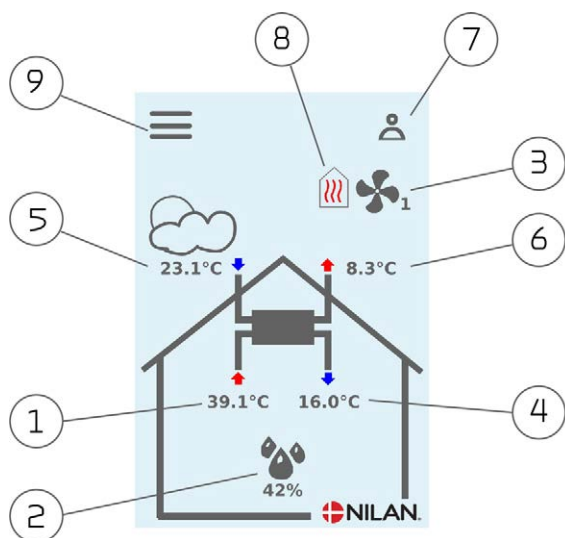

1. Shows the current room temperature in the house, measured via the extract air.
2. Shows the current air humidity. If a CO2 meter has been installed, it will be shown next to air humidity.
3. Shows the current fan speed level.
4. Shows the current supply air temperature
5. Shows the current outdoor temperature measured via the outdoor air intake
6. Shows the current discharge air temperature
7. Shows the menu icons listed below
8. Shows the mode icons listed below
9. Access to the settings menu which contains more settings options

Menu icons



Stop icon

Indicates that the unit has stopped



User selection icon

Indicates that the user selection function is active



Week program icon

Indicates that the week program function is active



Alarm icon

Is displayed during alarms or warnings

Mode icons



Compressor icon

Indicates that the compressor is active



Heating icon

Indicates that the unit is heating up the supply air via the compressor or the after-heating element



Cooling icon

Indicates that the unit is cooling the supply air via the compressor or the bypass

Settings options on the main screen

The settings options which the user needs in daily life can all be controlled from the main screen of the panel.



If you select the option of current room temperature, the desired room temperature will be displayed.

The desired room temperature can be adjusted by pressing the up-or-down arrows followed by the cancel icon (bottom left) or the accept icon (bottom right).



If you select the option of current fan speed level, the desired fan speed level will be displayed.

The desired fan speed level can be adjusted by pressing the up-or-down arrows followed by the cancel icon (bottom left) or the accept icon (bottom right).

Warnings and alarms

Should an error occur in the operation of the unit, a warning or an alarm will be displayed. A warning will appear in the top righthand corner in the menu bar.

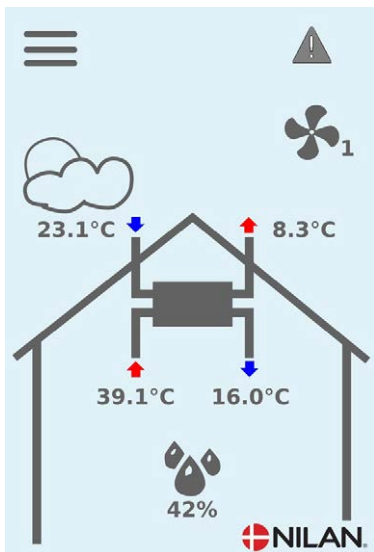

If you press the symbol, a description of the warning or the alarm will be displayed.

The warning or the alarm can be reset by pressing "Clear Alarm".

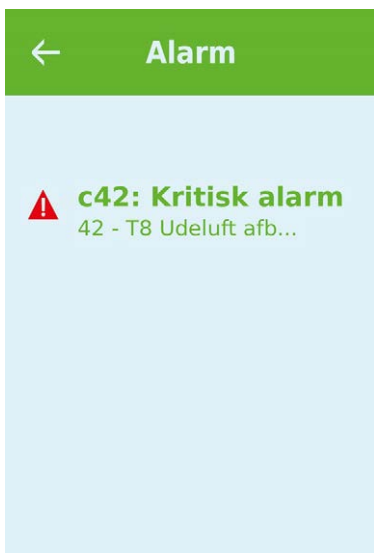

A warning indicates that something requires attention, for instance that filters need changing.
The unit operates normally.



An alarm indicates a serious fault with the unit that is likely to require investigation by an expert.
The unit has stopped.

Settings menu overview

The settings menu is constructed to make it easy to navigate through.



Service and maintenance

Maintenance

Regular maintenance

Your Nilan ventilation unit will last for many years if it is correctly maintained. Correct maintenance will also ensure that the unit runs optimally at all times with low energy consumption.

In the following we point out the regular maintenance which you can perform yourself and the annual service which should be carried out by a professional.

External cleaning

The ventilation unit

The outside of the unit can be cleaned with a mild soap solution.

The ceiling valves

Over time a ring may develop round the inlet valves. This is a natural process and is due to dust in the room air, not to defective filters or failure to change filters.

As very few painted ceilings are washable, you are recommended to vacuum round the valve and then wipe the area with a damp cloth.

It is a good idea to dismantle and clean the valves when necessary. The valves have been set by the installer for a specific airflow, so it is important not to rotate them, as this will change the setting and unbalance the ventilation system.

Water trap

The water trap can dry out and prevent water from draining from the condensate tray, because air will then blow into the unit. Condensate water will accumulate in the condensate tray. This will eventually overflow and potentially cause water damage to the surface supporting the unit.

The water trap should therefore be checked regularly and filled with water, especially in the summer when the risk of the water trap drying out is highest.

Filter replacement

The purpose of the filters is to protect the fans and the heat exchanger from dust and dirt, which may cause damage.

For operation to run smoothly, it is important to change the filters as required. The filter timer in Nilan's control system is set by default to indicate that filters should be replaced after 90 days, but this can be changed as required to 180 or 360 days.

If the filters are not changed, ventilation will lessen. This may cause the indoor climate to deteriorate and affect the automatic humidity control system of the unit.

Illustration of filter change

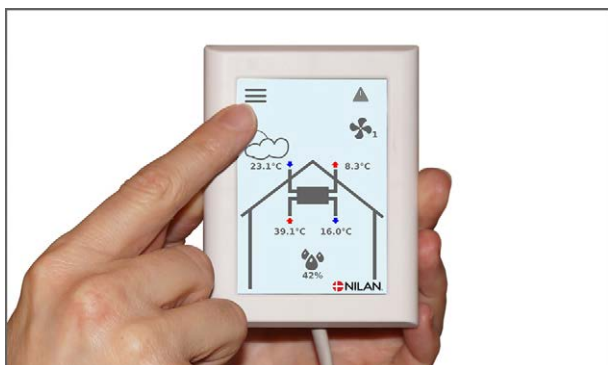

1. Switch off the unit on the control panel before opening the door.

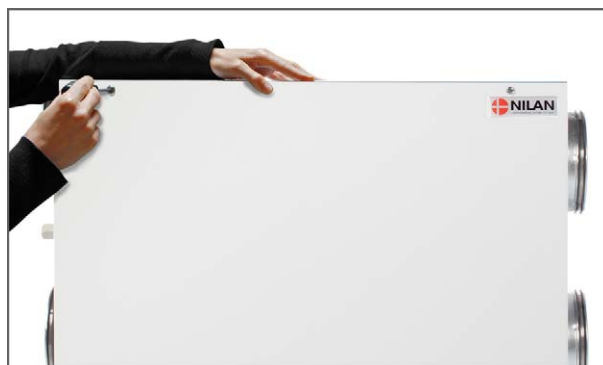

2. Loosen the screws in the front cover and lift the door out



3. Remove the two filters in the right side from the unit

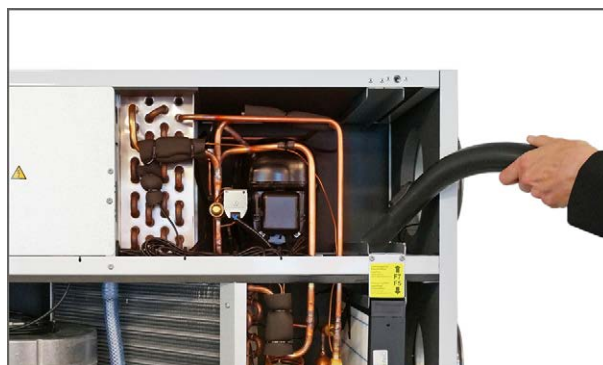

4. It is advisable that you vacuum the filter chambers for potential dirt and dust



5. The new filter must flip with the arrow away from the duct connections. The filter is placed in the marked track and the door closes again

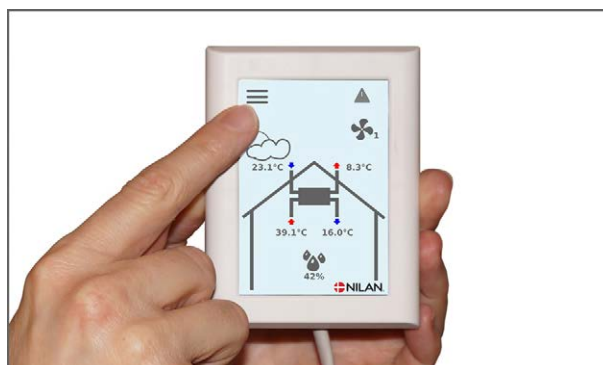

6. In the ALARM menu on the control panel, press the alarm symbol at the top right and reset the alarm here.

Illustration of filter change in FU15 (accessory)

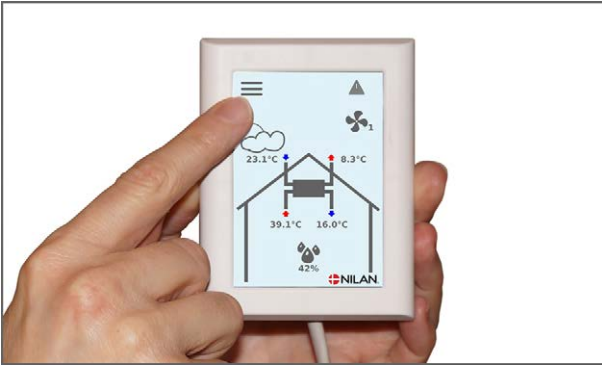

1. Switch off the unit on the control panel before opening the door.



2. Loosen the screws in the front cover and lift the door out



3. Remove the two filters in the right side from the unit

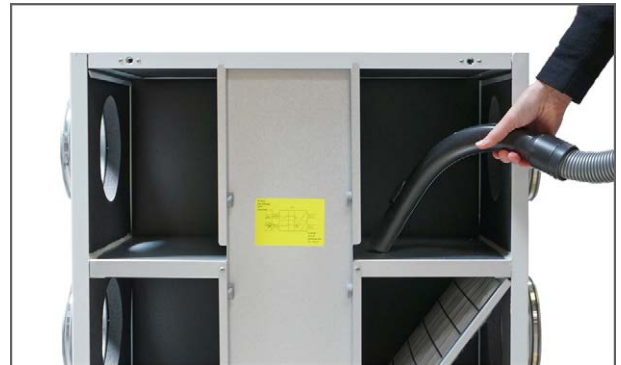

4. It is advisable that you vacuum the filter chambers for potential dirt and dust



5. Remove the filter sheet from the filter frame

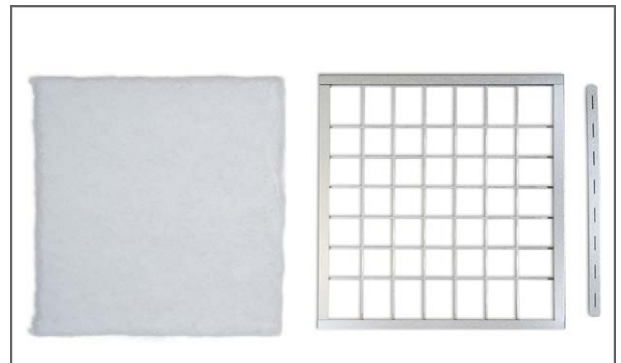

6. Keeping the smooth side facing downwards, place the new filter sheet in the filter frame



7. Press the filter sheet firmly in place and carefully push it to the sides of the filter frame. The filter is placed back in the unit with filter mat upward

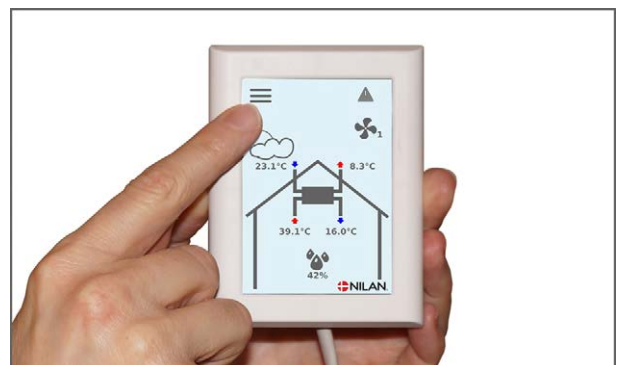

8. In the ALARM menu on the control panel, press the alarm symbol at the top right and reset the alarm here.

Service

Annual service

It is important to perform an annual service on the unit to ensure it will continue to perform optimally with low energy consumption and long service life.

You are recommended to take out a service agreement with the installer, as certain elements of the service require an authorised technician.

Internal cleaning

For hygienic reasons, it is important that the unit undergoes annual internal cleaning. This will prevent the formation of fungus and bacteria which impair the internal air quality.

- Wipe down the internal plate parts and pipes with a damp cloth and a mild soap solution.
- Check and clean the evaporator coil.
- Check and clean the counterflow heat exchanger. If necessary, it may be removed and rinsed with a shower head.
- Clean the condensate trays with a damp cloth and a mild soap solution.
- Check the condensate outlet to make sure the water can exit freely.

Check the air intake and outlet

It is important for operation of the unit that air can freely move through the air intake and outlet.

If roof stacks have been fitted to the air intake and outlet, check that they are not blocked with birds' nests, leaves or other dirt which can hamper air passage.

If, instead of roof stacks, grilles have been mounted in facades or eaves, check that they are not clogged with leaves or dirt. Grilles are particularly likely to become clogged.

Check ventilation ducts

It is important for operation of the unit that there is free air passage through the ventilation ducts.

After some years of operation, dirt will attach itself to ventilation ducts or tubes, and accumulations may lead to higher pressure drop in the ducts, leading to higher power consumption. It is therefore important to clean out the ducts when too much dirt has collected.

After attending to the inlet and outlet valves, it will be advisable to have them adjusted again, to ensure optimum operation of the ventilation system.

However, it will not be necessary to clean ducts more than every few years.

The heat pump

The heat pump must be inspected in accordance with applicable laws and regulations, such that it is kept in good condition and meets safety and environmental requirements.

The installer is obliged to inform the owner/user about applicable laws and regulations.

User settings

Ventilation settings

Stop the unit

If it is necessary to open the doors while servicing the unit, for instance when changing filters, the unit must be turned off.

The functions of the unit are activated in Settings under Operation.

If the unit is off, an icon appears on the main screen.



↳ Operation	Settings: Description:	Off / On The unit must be turned off before the doors are opened during a service
-------------	---------------------------	--

Operating function

You can program the unit to operate in "Auto", "Heating" or "Cooling" mode.



ATTENTION

The "Heating" and "Cooling" functions overrule the week program. If a week program has been set up, the mode will automatically change to "Auto" at the next change in the week program.



↳ Auto	Settings: Standard setting: Description:	Auto / Cooling / Heating Auto Auto: The unit operates in accordance with the selected values Cooling: The unit operates in accordance with the selected values, but cooling is possible in winter mode if the preconditions for cooling are present. Heating: The unit operates in accordance with the selected values, but the bypass damper cannot be opened and active cooling not be activated even if the preconditions are present.
--------	--	---

Alarm

You can read warnings and alarms in the "Alarm" menu. It is likewise possible to reset warnings and alarms in this menu.

When a warning or an alarm has been triggered, an icon appears on the main screen 



↳ Alarm number and name	Description:	When selecting this, a list will appear showing the alarm ID number, information about the type of alarm, and whether it is critical or not. (See the alarm list for more information) You can approve the alarm by selecting "Clear Alarm"
-------------------------	--------------	--



ATTENTION

When an alarm is active, it cannot be reset in the panel. When the alarm has been resolved, it will figure as inactive and it can be reset by selecting "Clear Alarm".

Show data

It is possible to read off current data for the unit.



↳ Operating state	Description:	Shows the operating setting in which the unit is running.
↳ T1 Outdoor air	Description:	Shows the outdoor temperature before reaching the pre-heating element.
↳ T2 Supply air	Description:	Shows the supply air temperature. If an after-heating element has been installed, T7 will be shown instead.
↳ T5 Condenser	Description:	Shows the condenser temperature.
↳ T6 Evaporator	Description:	Shows the evaporator temperature.
↳ T7 Supply air	Description:	Shows the supply air temperature if an after-heating element has been installed. Otherwise T2 will be shown.
↳ T10 Extract air/Room	Description:	Shows the current room temperature as measured in the extract air.
↳ Air humidity	Description:	Shows the current air humidity in the dwelling.
↳ CO2	Description:	Shows the current CO ₂ level in the dwelling (only if installed).
↳ Supply air fan	Description:	Shows the level at which the supply air fan is operating.
↳ Extract air fan	Description:	Shows the level at which the extract air fan is operating.
↳ Unit information	Description:	Press "Unit information" for more information.
↳ Unit type	Description:	Shows the name of the product the software has been set to work with.
↳ Software version	Description:	Shows the installed software version.
↳ Panel software	Description:	Shows installed software version on the panel.

Date/Time

It is important to set date and time correctly. It makes it easier to localise errors indicated in an error report. When logging data, it is important to be able to follow the history. The time is shown under "Date / Time" in the display.

← Date / Time

↳ Year	Description:	Select "Year" in the panel and then select the correct year.
↳ Month	Description:	Select "Month" in the panel and then select the correct month.
↳ Day	Description:	Select "Day" in the panel and then select the correct day.
↳ Hour	Description:	Select "Hour" in the panel and then select the correct hour.
↳ Minute	Description:	Select "Minute" in the panel and then select the correct amount of minutes.

Week program

You can program the unit to run in accordance with specific settings at fixed times during the week via a week program.

On the main screen an icon will be displayed when the week program is active



↳ Select program	Description:	You can select from the Programs 1, 2, 3 or off.
↳ Edit program	Description:	The selected week program is now active and can be edited.
↳ Monday	Description:	You can select either Monday, Tuesday, Wednesday, Thursday, Friday, Saturday or Sunday.
↳ Function 1	Description:	Under each function, you can set time, temperature and fan speed level.
↳ Start time	Settings: Standard setting: Description:	Hours and minutes 6:00 Set the time for the program to start. The program will run until the next change in the week program.
↳ Ventilation	Settings: Standard setting: Description:	Level 1 / Level 2 / Level 3 / Level 4 / Off Level 3 Select the desired fan speed level here.
↳ Temperatures	Settings: Standard setting: Description:	5 - 40 °C 22 °C Set the desired room temperature here.
↳ Function 2		Under each function, you can set time, temperature and fan speed level.
↳ Start time	Settings: Standard setting: Description:	Hours and minutes 8:00 Set the time for the program to start. The program will run until the next change in the week program.
↳ Ventilation	Settings: Standard setting: Description:	Level 1 / Level 2 / Level 3 / Level 4 / Off Level 1 Select the desired fan speed level here.
↳ Temperatures	Settings: Standard setting: Description:	5 - 40 °C 22 °C Set the desired room temperature here.
↳ Function 3	Description:	Under each function, you can set time, temperature and fan speed level.
↳ Start time	Settings: Standard setting: Description:	Hours and minutes 15:00 Set the time for the program to start. The program will run until the next change in the week program.
↳ Ventilation	Settings: Standard setting: Description:	Level 1 / Level 2 / Level 3 / Level 4 / Off Level 3 Select the desired fan speed level here.
↳ Temperatures	Settings: Standard setting: Description:	5 - 40 °C 22 °C Set the desired room temperature here.
↳ Function 4	Description:	Under each function, you can set time, temperature and fan speed level.

↳ Start time	Settings: Standard setting: Description:	Hours and minutes 22:00 Set the time for the program to start. The program will run until the next change in the week program.
↳ Ventilation	Settings: Standard setting: Description:	Level 1 / Level 2 / Level 3 / Level 4 / Off Level 1 Select the desired fan speed level here.
↳ Temperatures	Settings: Standard setting: Description:	5 - 40 °C 22 °C Set the desired room temperature here.
↳ Functions 5 and 6	Settings: Standard setting: Description:	Under each function, you can set time, temperature and fan speed level. Off The program will run until the next change in the week program.
↳ Reset program	Description:	You can reset the program by selecting the approve icon.

After-heating

This menu is only displayed if an after-heating element has been installed.



ATTENTION

An after-heating element is not standard, but it can be purchased as an accessory.

If you wish to control the supply air temperature, an after-heating element must be installed. An after-heating element allows you to control the supply air temperature, regardless of the outdoor temperature.

An external electrical or water after-heating element can be installed in the supply air duct.

← After-heating

↳ Activate	Settings: Standard setting: Description:	Off / On Off You can turn the after-heating on or off here.
------------	--	---

Cooling

The unit can cool the dwelling via active cooling by the heat pump. For the unit to switch to cooling mode it must operate in summer mode, or you must activate cooling in "Operating function".

Active cooling:

If the room temperature (measured in the extract air) is higher than the desired room temperature + the cooling setpoint, the compressor will start up and begin active cooling of the supply air. The compressor will stop when the room temperature falls below the cooling setpoint -1°C.

← Cooling

↳ Cooling setpoint	Settings: Standard setting: Description:	Off / +1 / +2 / +3 / +4 / +5 / +7 / +10 °C Off Off: Active cooling is deactivated. Setpoint + X °C: Indicates when active cooling is to start. The setpoint is the desired room temperature as selected on the front of the panel.
↳ Ventilation in connection with cooling	Settings: Standard setting: Description:	Off / 2 / 3 / 4 Off Off: The fan speed level does not change when the unit switches to cooling mode. Level 2-4: Select the fan speed level you want the unit to switch to when in cooling mode. This happens already at bypass cooling.

Air humidity

The primary purpose of ventilation is to extract humidity from the house so it does not damage the building, and to achieve a good indoor climate. During long periods with sub-zero temperatures, air humidity in the house may fall to a level that is critical for the building and for the indoor climate. Wooden floors, furniture and walls can be damaged by very dry air, which also whirls up dust, resulting in a poor indoor climate.

This is rectified by an integrated humidity control system that maintains good, relative air humidity. When the average air humidity in the house falls below a set level (default set at 30%), ventilation may be reduced. It will typically only be for a short period of time. This will help avoid further reduction of the air humidity in the house.

The humidity control system also has a function that allows increased ventilation, should the air humidity increase, for instance when having a bath. The risk of mould growth in the bathroom is reduced, and the bathroom mirror will rarely steam up.

The humidity control system follows the average air humidity level measured over the previous 24 hours. In this way the system automatically adapts to summer and winter conditions.

← Air humidity

↳ Vent.low humidity	Settings: Standard setting: Description:	Level 1 / Level 2 / Level 3 / Level 4 / Off Level 1 At low humidity, the unit changes to the set fan speed level.
↳ Low humidity level	Settings: Standard setting: Description:	15 ↔ 45 % 30 % The control system calculates an average air humidity level measured over the previous 24 hours. If the average air humidity in the extract air falls below this level, the "Low humidity" function will be activated. Note! The function is only active in winter mode.
↳ Vent.high humidity	Settings: Standard setting: Description:	Level 2 / Level 3 / Level 4 / Off Level 3 At high humidity levels, for instance when having a bath, the unit changes to the set fan speed level.
↳ Max time high humidity	Settings: Standard setting: Description:	1 ↔ 180 minutes / Off 60 minutes The function "High humidity" stops when actual humidity falls below 3% above the average air humidity. The run of this function has been time limited.

CO₂

This menu is only displayed if a CO₂ sensor has been installed.

**ATTENTION**

CO₂A CO₂ sensor is not a standard part of all units, but may be purchased as an accessory.

If the number of people using a building varies considerably, controlling ventilation through the CO₂ level in the extract air may be a good solution. This function is often used in offices and schools where use varies greatly during the day and during the week.

← CO₂

↳ Vent.high CO ₂ level	Settings: Standard setting: Description:	Level 2 / Level 3 / Level 4 / Off Level 3 Here you indicate the fan speed level at which the unit is to operate at high CO ₂ level.
↳ High CO ₂ level	Settings: Standard setting: Description:	650 ↔ 2500 ppm 800 ppm Here you indicate the CO ₂ level at which the unit is to switch to high fan speed level.
↳ Normal CO ₂ level	Settings: Standard setting: Description:	400 ↔ 750 ppm 600 ppm Here you indicate the CO ₂ - level at which the unit is to switch to normal control.

Air exchange

Low humidity in the dwelling can be prevented by reducing ventilation at low outdoor temperatures. This function can be used in countries with regular sub-zero temperatures and at high altitudes where the outdoor air is very dry.

This function can also be used at cold outdoor temperatures if no after-heating element has been installed, and the supply air feels too cold.

← Air exchange

↳ Type of ventilation	Settings: Standard setting: Description:	Energy/Comfort Energy Energy: Here, an energy-optimized operation is ensured by regulating the supply air in relation to the set temperature curve. Comfort: Here, the air change is always balanced. The ventilation level on the supply air and extract air is always the same.
↳ Low temperature curve	Settings: Standard setting: Description:	15 ↔ 46 °C 38 °C When curve controlled, the supply air will be temperate at a time, as a ventilation step is regulated down or up. Min. curve is level 1
↳ High temperature curve	Settings: Standard setting: Description:	39 ↔ 60 °C 50 °C When curve controlled, the supply air will be temperate at a time, as a ventilation step is regulated down or up. Max. curve is level 4
↳ Low temperature compressor start	Settings: Standard setting: Description:	Off / 0 ↔ 15 °C Off Here you indicate whether, at low outdoor temperatures, the heat pump is to start up even if heating is not required.
↳ Winter low vent.	Settings: Standard setting: Description:	Level 1 / Level 2 / Level 3 / Off Off Here you select the fan speed level at which the unit is to operate at low outdoor temperatures.
↳ Level winter low	Settings: Standard setting: Description:	-20 ↔ 10 °C 0 °C Here you indicate the outdoor temperature at which operation is to change to "Winter low".

Condenser curve controlled

Supply air [%]

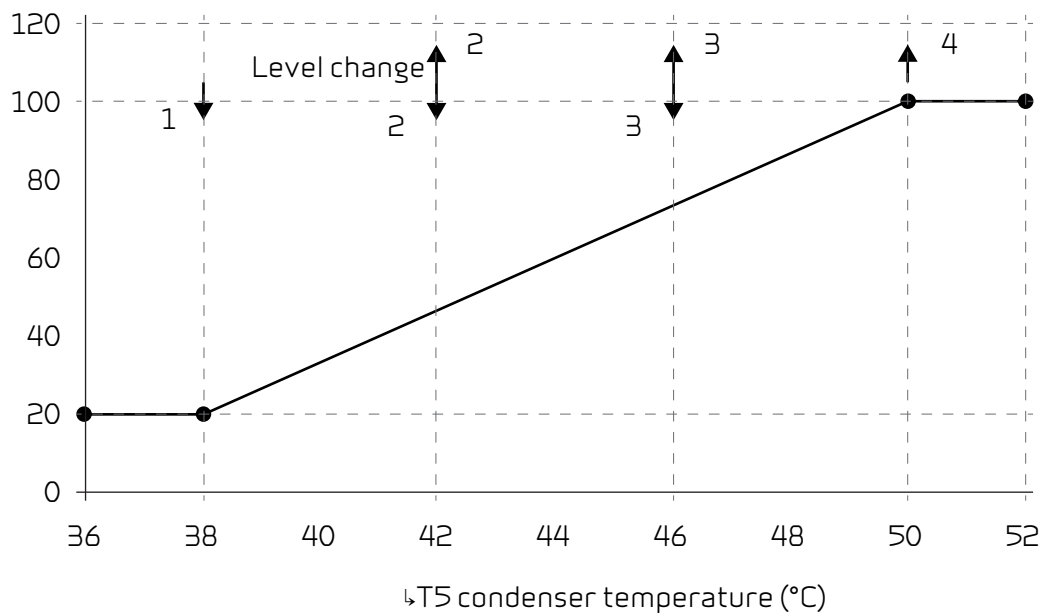

Air filter

The filter alarm has a timer. Its factory setting is 90 days between each filter change. If you want to add pressure-controlled filter change, pressure sensors can be connected via digital input and adjustment in the filter menu.

← Air filter

<p>↳ Filter alarm</p>	<p>Settings: Standard setting: Description:</p>	<p>30 / 90 / 180 / 360 90 days The number of days between filter changes can be set as required. For optimal operation, it is important that filters are clean. A blocked exchanger will increase power consumption.</p>
-----------------------	---	--

Temp. control

If you wish to control the supply air temperature, an after-heating element must be installed. An after-heating element allows you to control the supply air temperature, regardless of the outdoor temperature.

An external electrical or water after-heating element can be installed in the supply air duct.



ATTENTION

When heating is not needed in the dwelling, the supply air temperature may fall below the minimum temperature.

← Temp. control

↳ Min. supply air summer	Settings: Standard setting: Description:	5 ↔ 16 °C 14 °C Here you set the minimum supply air temperature that the unit should provide in the summer. If the outdoor air temperature is lower than stated, the bypass damper closes, the system runs with heat recovery.
↳ Min. supply air winter	Settings: Standard setting: Description:	14 ↔ 22 °C 16 °C Here you set the minimum supply air temperature that the unit should provide in the winter. Only effective with an after-heating element.
↳ Max. supply air summer	Settings: Standard setting: Description:	16 ↔ 25 °C 22 °C Here, the supply air temperature is set, the unit as maximum must be able to blow in with when heat is needed.
↳ Max. supply air winter	Settings: Standard setting: Description:	22 ↔ 50 °C 25 °C Here you can set the maximum supply air temperature that the unit should provide when heating is required in the winter (only displayed on the panel if the unit is fitted with an after-heating element).
↳ Summer change	Settings: Standard setting: Description:	5 ↔ 30 °C 12 °C Here you set the minimum outdoor temperature for the unit to operate in summer mode. If the outdoor air temperature is lower, the unit will operate in winter mode.

Language

The unit is factory-set to Danish language. You can change the texts to other languages.

← Language



↳ Danish	Description:	Select the desired language on the panel.
----------	--------------	---









Alarm list













VPL unit

Alarm list

The list below relates to Comfort units, and the events are divided into the following categories:

-  Warning Operation continues, but something no longer functions optimally.
-  Critical Operation has stopped partially or completely as a serious error requires immediate attention.

ID	Type	Display text	Description / cause	Rectification of error
01		Hardware error	Error in the hardware of the control system.	If resetting does not help, contact service.
02		Alarm timeout	A warning alarm has become a critical alarm.	Register alarm and reset. If the alarm persists, contact service.
03		Fire alarm activated	The unit has stopped because the fire thermostat has been activated.	If there has been no fire, contact service.
04		Pressure switch	The high-pressure switch in the refrigeration circuit has been triggered, possibly due to: <ul style="list-style-type: none"> Extremely warm outdoor air supply Clogged filter Defective fan 	Check for faults and reset the alarm Contact service if you cannot reset the alarm or if alarms often occur.
06		Error in de-icing the heat pump	The de-icing time has been exceeded. The exchanger or the heat pump has failed to de-ice within the maximum time. This may be due to the unit being exposed to very low outdoor temperatures.	Contact service if resetting the alarm does not help. Register the current operating temperatures from the "Show data" menu in order to ease the service process.
8		Frost thermostat triggered	Temperature sensors: Only on units with a T9 sensor: Frost thermostat in water heating element triggered.	Check for adequate insulation around the water heating element and its connections. Reset alarm.
7		Frost in after-heating element	Temperature sensors: Units without a T9 sensor: Frost thermostat in water heating element triggered. Units with a T9 sensor: Water heating element could not reach 20°C within 6 min.	Check for adequate insulation around the water heating element and its connections. Reset alarm.
10		Over temperature Electrical after-heating	The electrical heating element has overheated. A lack of airflow may be due to clogged filters, a blocked air intake or a defective supply air fan.	Check that air flows into the dwelling. Check filters and the air intake. Reset alarm. If the above does not resolve the issue, contact service.
11		Low flow over the electrical heating element	Lack of airflow in the supply air. See alarm code 10.	See alarm code 10.

15		The room temperature is too low	When the room temperature is below 10°C, the unit will stop in order to prevent further cooling of the house. This may, for instance, be during a period when the house is unoccupied and the heating system is off.	Heat up the house and reset the alarm.
16		Software error	Error in the control system program.	Contact Service.
17		Watchdog warning	Error in the control system program.	Contact Service.
18		Content of database changed	Parts of the program setting have been lost. This may be due to a prolonged power cut or a lightning strike. The unit will continue to operate with standard settings.	Reset alarm. Set the desired week program. Contact service if the unit does not operate to your satisfaction/ as before, as some subprograms may have been lost. (Subprogram is only available for service).
19		Change filter	The filter monitor has been set at X amount of days for check-up/change of filter (30, 90, 180, 360 days). The standard setting is 90 days.	Clean/change filter. Reset alarm.
21		Check date and time	Is displayed during power cuts.	The settings of the weekly clock must be checked and adjusted if necessary. Reset alarm.
22		Error in air temperature	It is impossible to heat the supply air as desired (only applicable if you have an after-heating element). The after-heating element and the unit cannot increase the temperature to the desired level.	Set a lower supply air temperature. Reset alarm.
27-58		Error on the temperature sensor	One of the temperature sensors has either short circuited, been disconnected or is defective.	Register which sensor, Tx, is faulty and contact service.
71		Error de-icing heat exchanger	Max. de-icing time exceeded for counterflow heat exchanger. This may be due to the unit being exposed to very low temperatures.	If resetting the alarm does not help, contact service. Register the current operating temperatures from the "SHOW DATA" menu in order to ease the service process.
72		Abnormal low evaporator temperature	Abnormal evaporator temperature (T6) is due to insufficient air flow.	Change filters, check outdoor air intake is not stopped. In case of constant fault contact service.
92		Backup error	Error when writing or entering the installer's settings.	Contact service.
96		Error in damper test	Damper (open / closed) not fulfilled	Must be unset in the Alarm

Product data

Declaration of compliance

EF-Overensstemmelseserklæring

28. oktober 2011

Fabrikant

Navn: Nilan A/S
 Adresse: Nilanvej 2
 8722 Hedensted
 Land: DK
 Telefon: 76752500
 erklærer hermed, at

Produkt

Produkt nr.: 71363B, 71333B
 Navn: VPL 15
 Type: Luft/luft aktiv varmegenvinding

er i overensstemmelse med

Rådets Direktiv 97/23 om indbyrdes tilnærmelse af medlemsstaternes lovgivning om trykbærende udstyr.

Rådets Direktiv af 2006 om tilnærmelse af medlemsstaternes lovgivning om elektrisk materiel bestemt til anvendelse inden for visse spændingsgrænser (2006/95/EF)

Europa-Parlamentets og Rådets direktiv 2006/42/EF om indbyrdes tilnærmelse af medlemsstaternes lovgivning om maskiner.

er fremstillet i overensstemmelse med følgende nationale standarder, der gennemfører en harmoniseret standard:

EN 60335-1+A1, A11:2006

Elektriske apparater til husholdningsbrug o.l. — Sikkerhed — Del 1: Almindelige bestemmelser EN 60335-1+A1, A11:2006

EN 60335-2-40:2003

Sikkerhed af elektriske apparater til husholdningsbrug o.l. — Del 2-40: Særlige bestemmelser for elektriske varmepumper, luftkonditionerings-apparater og luftaffugtere (IEC 60335-2-40:2003)

EN 60335-2-80:2003

Elektriske apparater til husholdningsbrug o.l. — Sikkerhed — Del 2-80: Særlige bestemmelser for ventilatorer (IEC 60335-2-80:2003)

EN ISO 12100-1/A1:2009

Maskinsikkerhed — Grundlæggende begreber og generelle principper for projektering, konstruktion og udformning — Del 1: Grundlæggende terminologi og metodik (ISO 12100-1/A1:2009)

EN ISO 12100-2/A1:2009

Maskinsikkerhed — Grundlæggende begreber og generelle principper for projektering, konstruktion og udformning — Del 2: Tekniske principper (ISO 12100-2/A1:2009)

Titel: R&D Engineer
 Navn: Rune H. Mikkelsen
 Firmanavn: Nilan A/S

28/10-2011

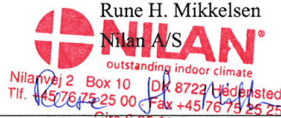

Dato

Signatur

United Kingdom:

SL Services
25 St Leonards Road, Horsham
RH13 6EH West Sussex

Tlf. +44 (0) 7919 444452

stuart315@aol.com
www.nilanuk.com

Ireland:

Nilan Ireland
Ballylahive, Abbeydorney

Tlf. +353 (0) 87 9798361

maurice@nilan.ie
www.nilanireland.ie



Nilan A/S
Nilanvej 2
DK-8722 Hedensted

Tlf. +45 76 75 25 00
Fax +45 76 75 25 25

nilan@nilan.dk
www.nilan.dk