

Installation instruction

CTS 602 by Nilan

Combi 302 Polar

Version: 10.00, 28-11-2016



Table of contents

Table of contents	2
Figure table	2
Introduction.....	3
Power supply.....	4
Assembly of Combi 302 Polar.....	5
Condensation drain / water seal	6
Ducting	7
Starting and set up of the CTS 602 control	8
Starting	8
Set up of the CTS 602 control	8
Activating the SERVICE menu	9
Inlet heating	10
Heating surface.....	11
Air quality	12
Air exchange.....	13
Defrost	14
Temp. control.....	15
Inlet control	16
Room control	17
Restart	18
Preset	19
Manual.....	20
Modbus.....	21
Datalog	22
System dimension	23
Accessories / spare parts	24

Figure table

Figure 1: CTS 602 control.....	4
Figure 2: Mounting the Combi 302 Polar	5
Figure 3: Condensation drain / water seal.....	6
Figure 4: Insulation of ducting.....	7
Figure 5: CTS 602 control.....	8
Figure 6: Headlines in the service menu.....	9
Figure 7: The "Inlet heating" Menu.....	10
Figure 8: The "Central heating" menu	11
Figure 9: The "Air quality" Menu	12
Figure 10: The "Air exchange" Menu	13
Figure 11: The "Defrost" Menu	14
Figure 12: The "Temp. control" Menu	15
Figure 13: The "Inlet control" Menu.....	16
Figure 14: The "Room control" Menu.....	17
Figure 15: The "Restart" Menu	18
Figure 16: The "Preset" Menu.....	19
Figure 17: The "Manual" Menu	20
Figure 18: The "Modbus" Menu	21
Figure 19: The "Datalog" Menu.....	22
Figure 20: System dimension	23

Introduction



Please control that the following documents have been delivered together with the unit:

- Directions for assembly & use (this document)
- CTS 602 directions
- Electrical chart

Should you have any questions on how to operate the system, contact your nearest Nilan dealer, who you can find at www.nilan.dk/dealers

Combi 302 Polar is a combined passive and active heat recovery plant with a cooling function.

The standard delivery of the Combi 302 Polar is with filter classes F5 (EU5) in the exhaust device and F7 (EU7) in the injection.

The unit can be equipped with different accessories e.g. hygrostat and filter box with pollen filter.

Operating the unit is done with the CTS 602 control. The control has many functions such as menu based attendance, week programme, time controlled filter guard and adjustment of the velocity of the ventilator. (Directions for the CTS 602 control is described in another document delivered with the unit.)

For accessories see page 23.



We recommend that the system as well as the installation is adjusted/checked to ensure a healthy indoor climate and optimal operation.

Power supply



Power supply including safety switch must be installed by an authorized electrician. The Combi 302 Polar unit must be connected according to the attached electrical chart.

The unit is delivered with 1m test cable for the CTS 602 panel. The panel should be connected to the CTS 602 control in the unit with cable type 2x2x0.25mm² twisted in pairs. (Maximum length 50m).

The CTS 602 panel must be placed dry and frost-proof. The panels' integrated feeler prevents further cooling of the building if the primary heat-supply stops by stopping the ventilation if the panel feeler gets below a specific value. (Factory setting is 10°C; the value can be set from 1°C to 20°C.)

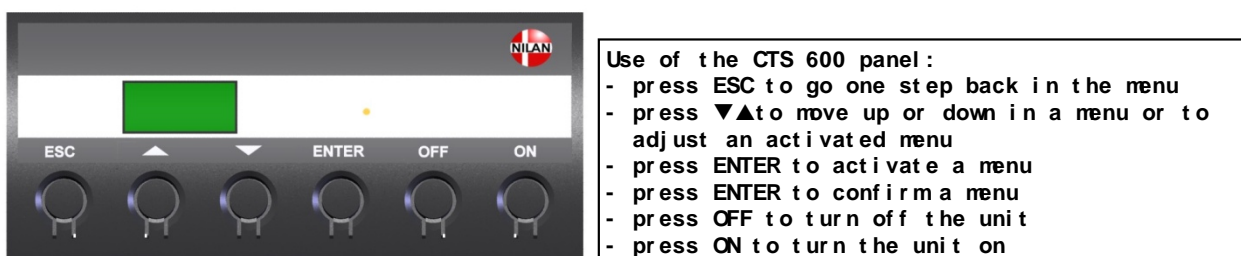

Figure 1: CTS 602 control

If a water post-heating element is installed, the control valve and circulation pump must be electronically connected as described in the provided wiring diagrams.

Assembly of Combi 302 Polar



When mounting the Combi 302 Polar future service and maintenance should be considered.

It is recommended to have minimum 60 and 30 cm free space in front of- and at the end of the plant.

The system must be level due to the condense outlet. The condense outlet requires a clearance height of minimum 11.5 cm under the outlet connection piece.

It is not necessary to re-insulate the system as it is delivered with a 20 mm standard insulation.

The system is low-noise and low-vibration. However, potential vibrations spreading from the system to the individual building parts must be taken into account. We recommend a minimum distance of 30 mm from building parts and other fixtures. It is recommended to place the plant on vibration absorbers to separate the plant and the base

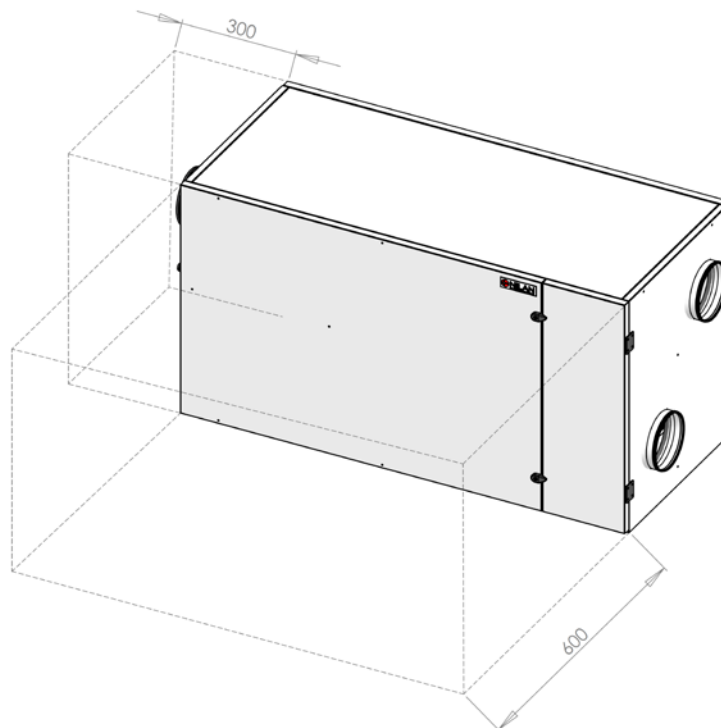

Figure 2: Mounting the Combi 302 Polar

Condensation drain / water seal

The Combi 302 Polar unit is delivered with a 20mm condensation drain. (PVC, GF-fittings). The drain is placed under the discharge.



The condensation drain should be carried with an even inclination of at least 1 cm per meter, frost-proof to the nearest outlet. The overflow from the safety valve should also be carried to the nearest outlet.



To avoid frost problems it can be necessary to supply the condensation drain with a heating cable. It is the plumbers' responsibility to secure the drain.

When the system is running, there can be a vacuum of up to 500Pa (corresponding to 50mm water column) in the outlet. For this reason, the difference in height in the water seal must be minimum 50mm. This means that the first bend of the water seal must be at least twice as long in order for the system to be able to dispose of the condense water (see figure 3).

The condensation drain must be airproof from the unit to the water seal in order for the condensation water to be let away from the unit. If the condensation drain is not airproof false air will be sucked in to the unit and the water will stay inside the unit.

The water seal can dry out and avoid the water from running out of the unit. Therefore the water seal should be tested regularly and refilled with water if necessary. An elevated height of the water seal will reduce the need for refilling with water.

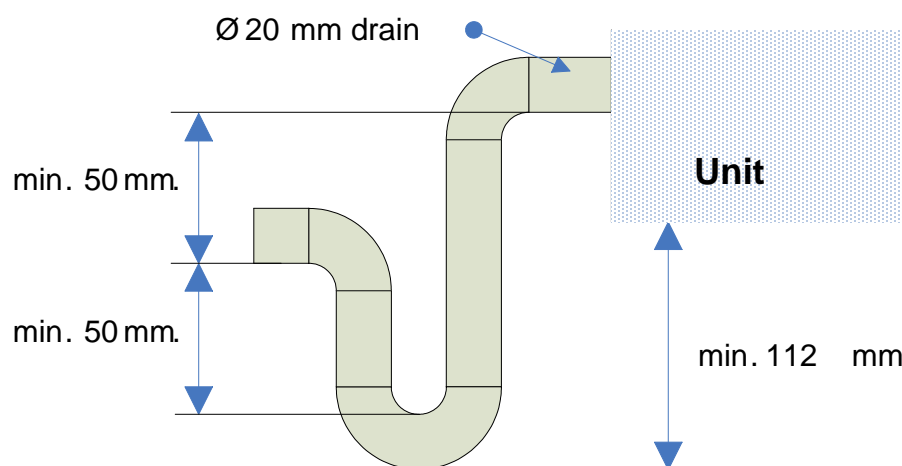

Figure 3: Condensation drain / water seal



The water seal should be tested as described below. (the unit must be connected to the ducting and the front door should be closed):

The condensation tray is filled with water and the unit is started at the highest ventilation step. The unit should run for a couple of minutes. Check that the condensation tray is empty when the test is finished.

Ducting

We recommend that there are used ducts and fittings with rubber packing that meet sealing class B and that the connections between the unit and the ducting are made with 1 metre sound absorbing flexible transitions as regards sound reduction.

The ducts should be shortened with a hacksaw or an angle grinder and laid out according to the working drawing. The ducts are typically laid out on the main beam of the truss frame and are secured with hole belts or they are being hanged in assembly belts. Please avoid any unnecessary area reductions and breaks of the ducting.

The ducts should be insulated – in some cases with the ordinary attic-insulation. All ducts should be insulated with 100mm mineral wool to avoid heat loss and condensation. This also applies for flexible transitions. It is recommended that the insulation is carried out with 2 layers of 50mm. If the ducts are laid out in an unheated room it will cause condensation problems if the unit are turned off for a longer period of time as the hot air from the heated room will rise to the ducts and cause condensation which can cause damp problems.

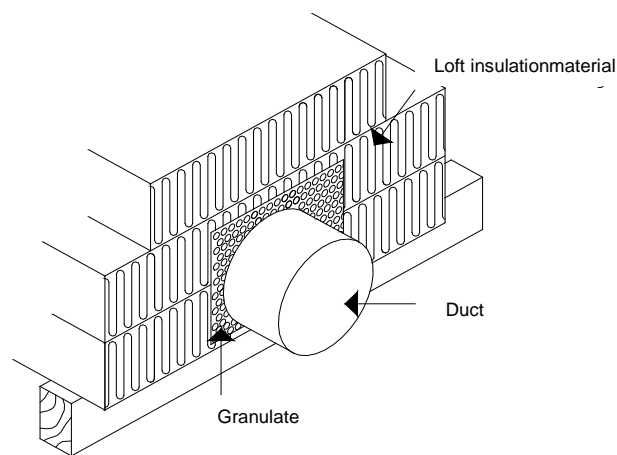

Figure 4: Insulation of ducting

The discharge duct is leading the exhaust air away either above the roof or through the outer wall. It is important that the roof cowl has at least the same open space as the duct leading to the roof cowl. A reduction at this place will cause an unnecessary pressure drop which can lead to a reduced ventilation output.

The holes for the inlet- and exhaust valves should be cut according to the mounting-frame for the prescribed valve. The frame for the valve must be secured with screws before placing the valve in the frame. The valves are placed in accordance with the size, construction and use of the room. As an example we would not recommend placing an inlet valve just above people with sedentary work because the inlet air in some cases would be experienced as a draught.

Starting and set up of the CTS 602 control

Starting

Before starting the Combi 302 Polar please check all functions as cooling, heating and heating surface if installed.

Set up of the CTS 602 control

In this passage we will go through the service menu of the CTS 602 control. For daily use of the CTS 602 control please see the CTS 602 directions. (delivered together with the Combi 302 Polar).



Use of the CTS 600 panel :

- press ESC to go one step back in the menu
- press ▼▲ to move up or down in a menu or to adjust an activated menu
- press ENTER to activate a menu
- press ENTER to confirm a menu
- press OFF to turn off the unit
- press ON to turn the unit on

Figure 5: CTS 602 control

Activating the SERVICE menu

Press and hold ▼ and **ENTER** simultaneously for 10 seconds. The SERVICE menu can then be accessed. Press ▼ repeatedly until **SERVICE** appears on the display. Press **ENTER** to activate the SERVICE menu. It is then possible to scroll through the SERVICE menu options using the ▲▼ buttons. The options available on the SERVICE menu are shown in the figure below.

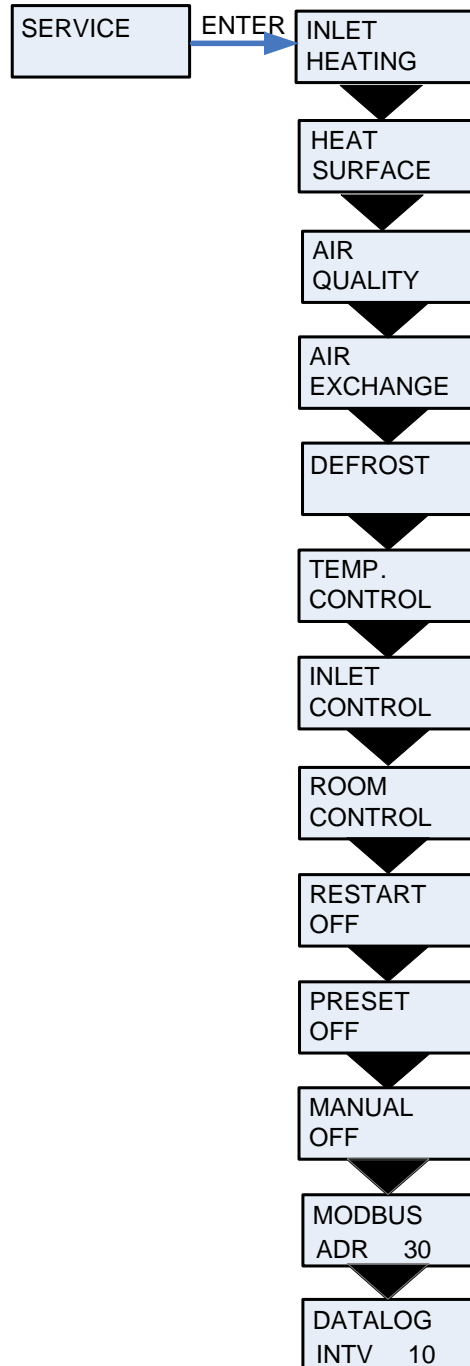

Figure 6: Headlines in the service menu

Inlet heating

In the "Inlet heating" menu it is possible to activate and de-activate the heating surface in the inlet air and to set the regulation time.

On the CTS602 control panel, press:

- ESC to return to the previous menu
- ▼▲ to scroll upwards or downwards through the menus or to adjust the setting of an activated menu option
- ENTER to activate a menu option
- ENTER to confirm a menu option setting
- OFF switch off the controls
- ON to switch on the controls

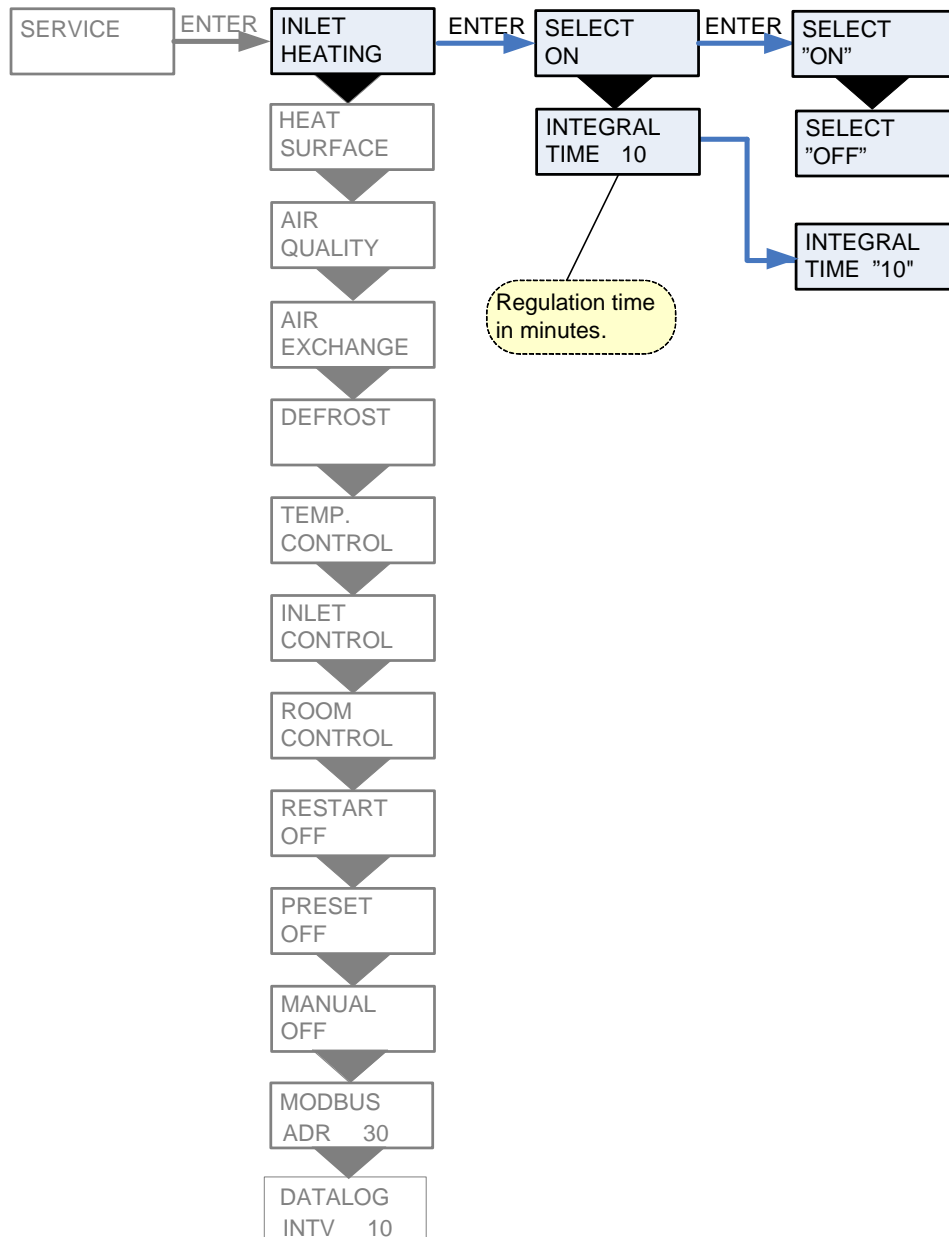

Figure 7: The "Inlet heating" Menu

Heating surface

The unit can be equipped with a heating surface.

It is possible to retrofit a heating surface. The surface must be activated in the CTS 602 control in order to function together with the unit and for the frost-protection to be active.

When installing a heating surface T7 is the temperature sensor in the inlet.

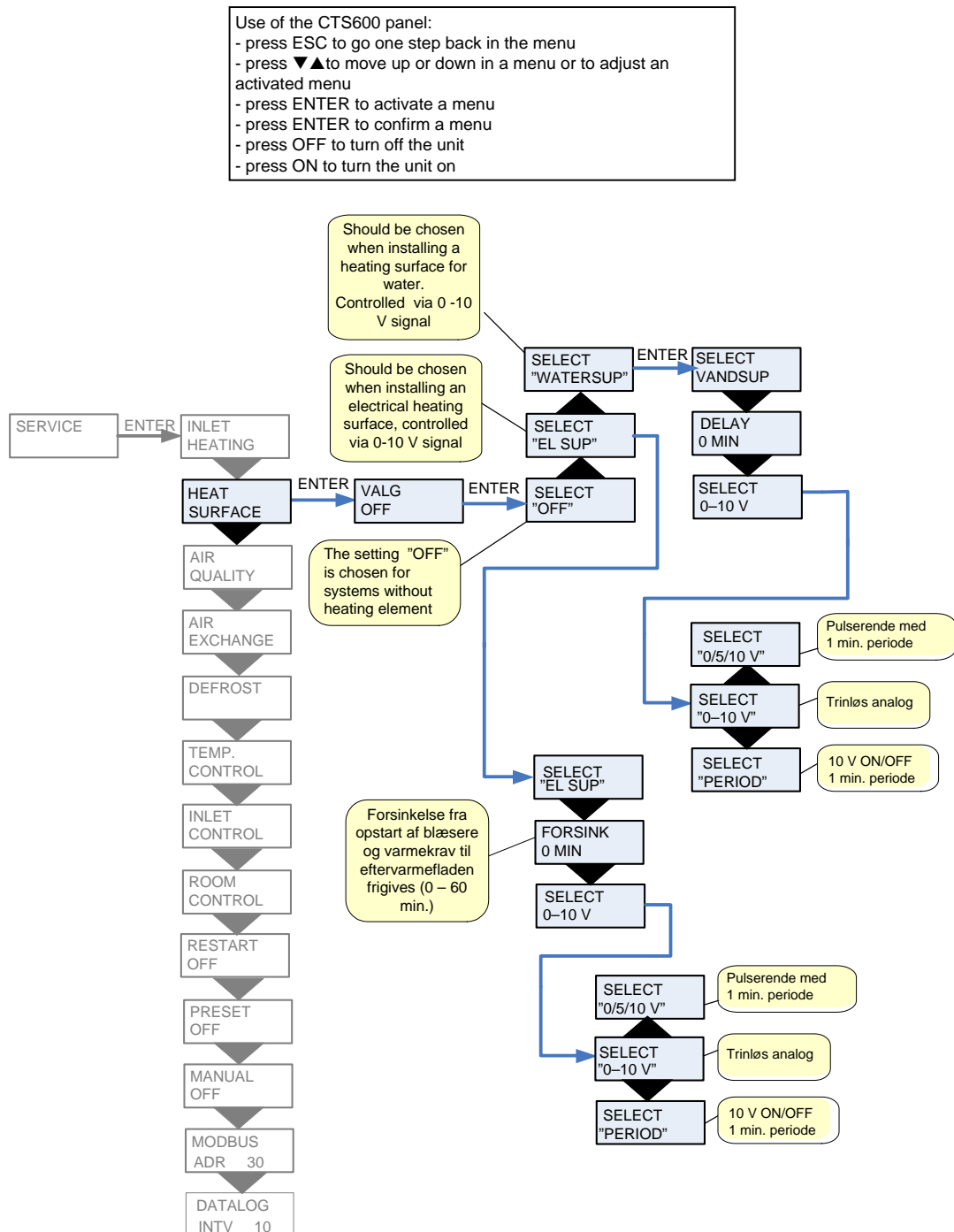

Figure 8: The “Central heating” menu

Air quality

In the "Air quality" menu it is possible to choose between 3 types of regulation: Humidity, Humidity + CO₂ or OFF.

On the CTS602 control panel, press:

- ESC to return to the previous menu
- ▼▲ to scroll upwards or downwards through the menus or to adjust the setting of an activated menu option
- ENTER to activate a menu option
- ENTER to confirm a menu option setting
- OFF switch off the controls
- ON to switch on the controls

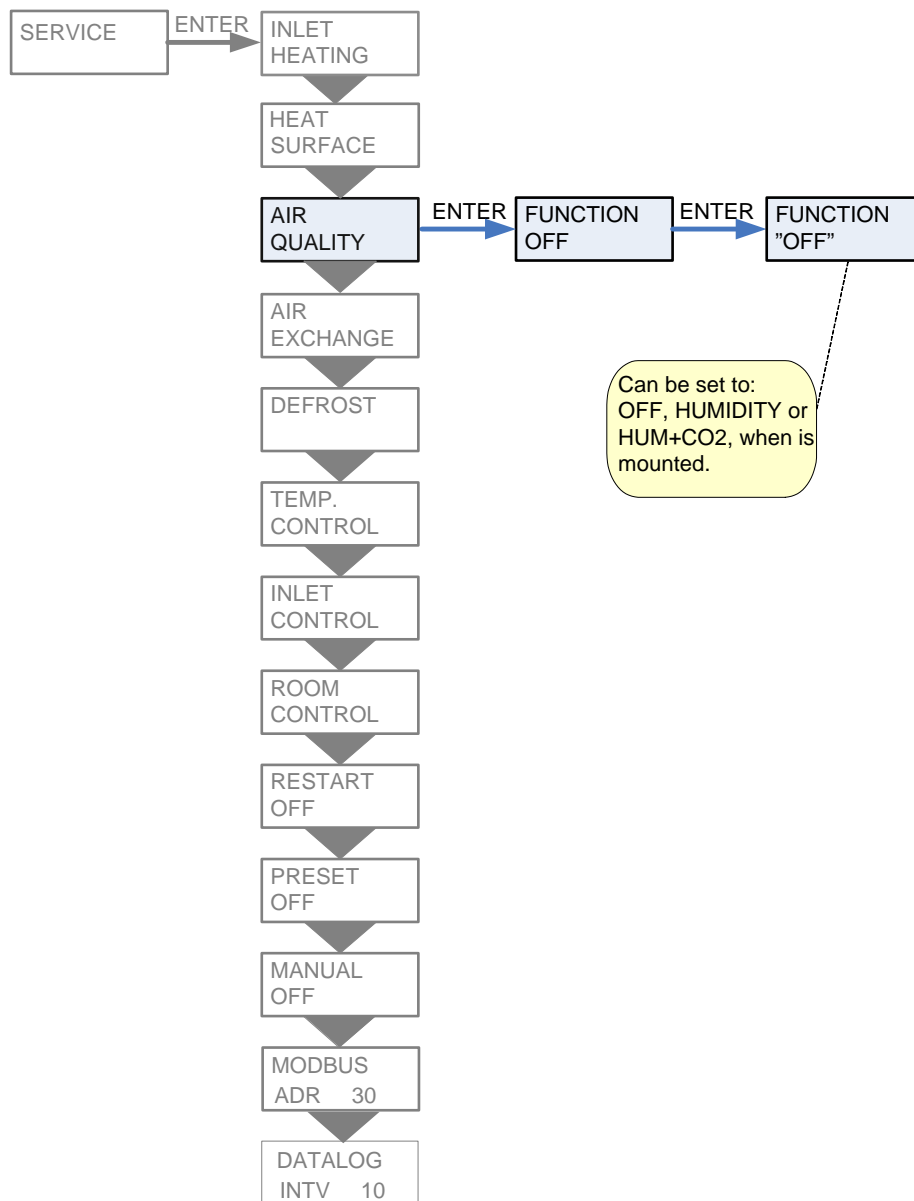

Figure 9: The "Air quality" Menu

Air exchange

The AIR EXCHANGE menu allows four ventilation steps (air quantities) to be set. Individual values for inlet and exhaust can be set for each ventilation step.

A minimum ventilation step for inlet air and minimum and maximum steps for exhaust air can also be set.

On the CTS602 control panel, press:

- ESC to return to the previous menu
- ▼▲ to scroll upwards or downwards through the menus or to adjust the setting of an activated menu option
- ENTER to activate a menu option
- ENTER to confirm a menu option setting
- OFF switch off the controls
- ON to switch on the controls

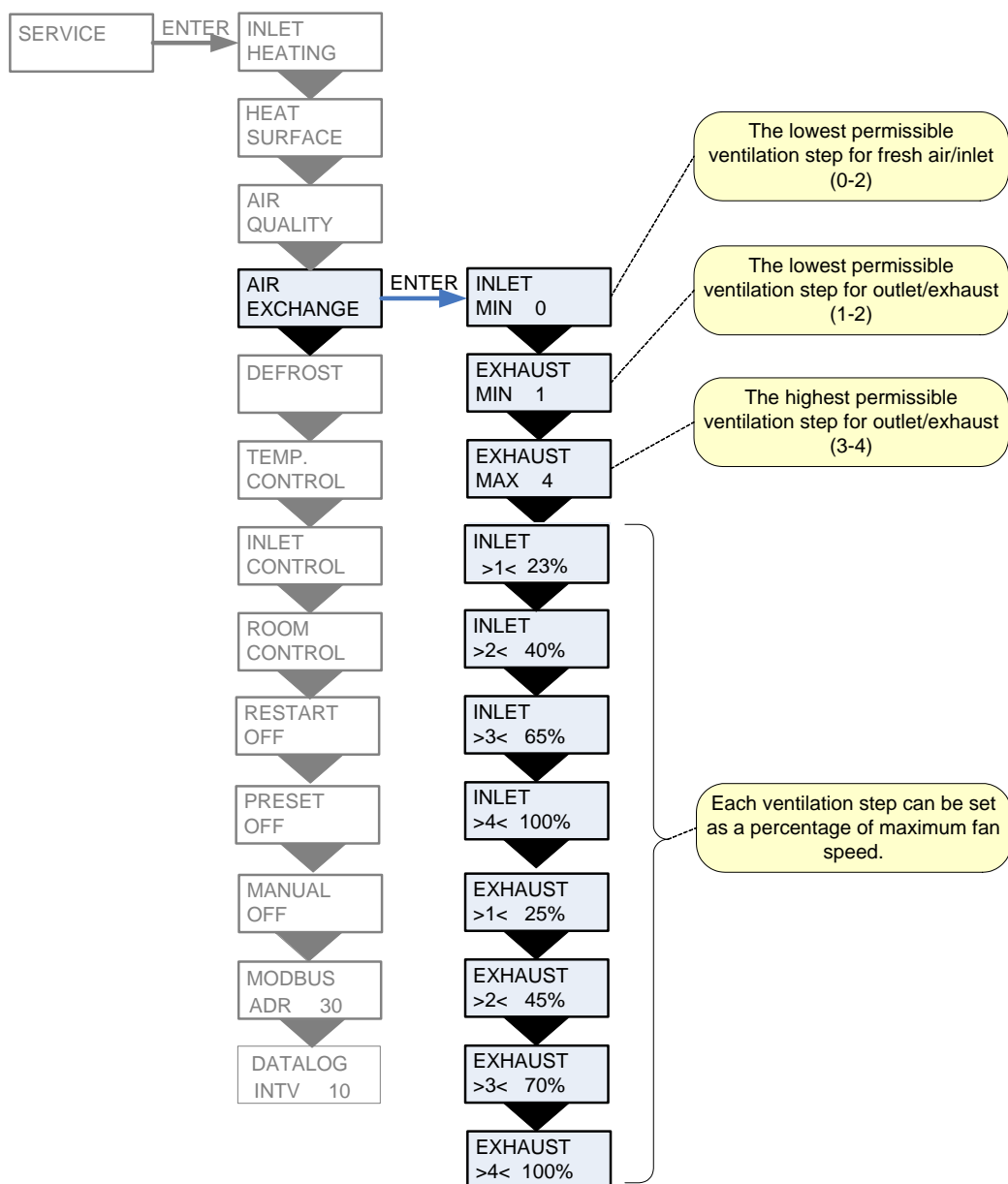

Figure 10: The "Air exchange" Menu

Defrost

The DEFROST menu determines the mode of system operation while the evaporator surface and the counter flow heat exchanger in the exhaust air flow is being defrosted.

Options that flash are indicated by " "

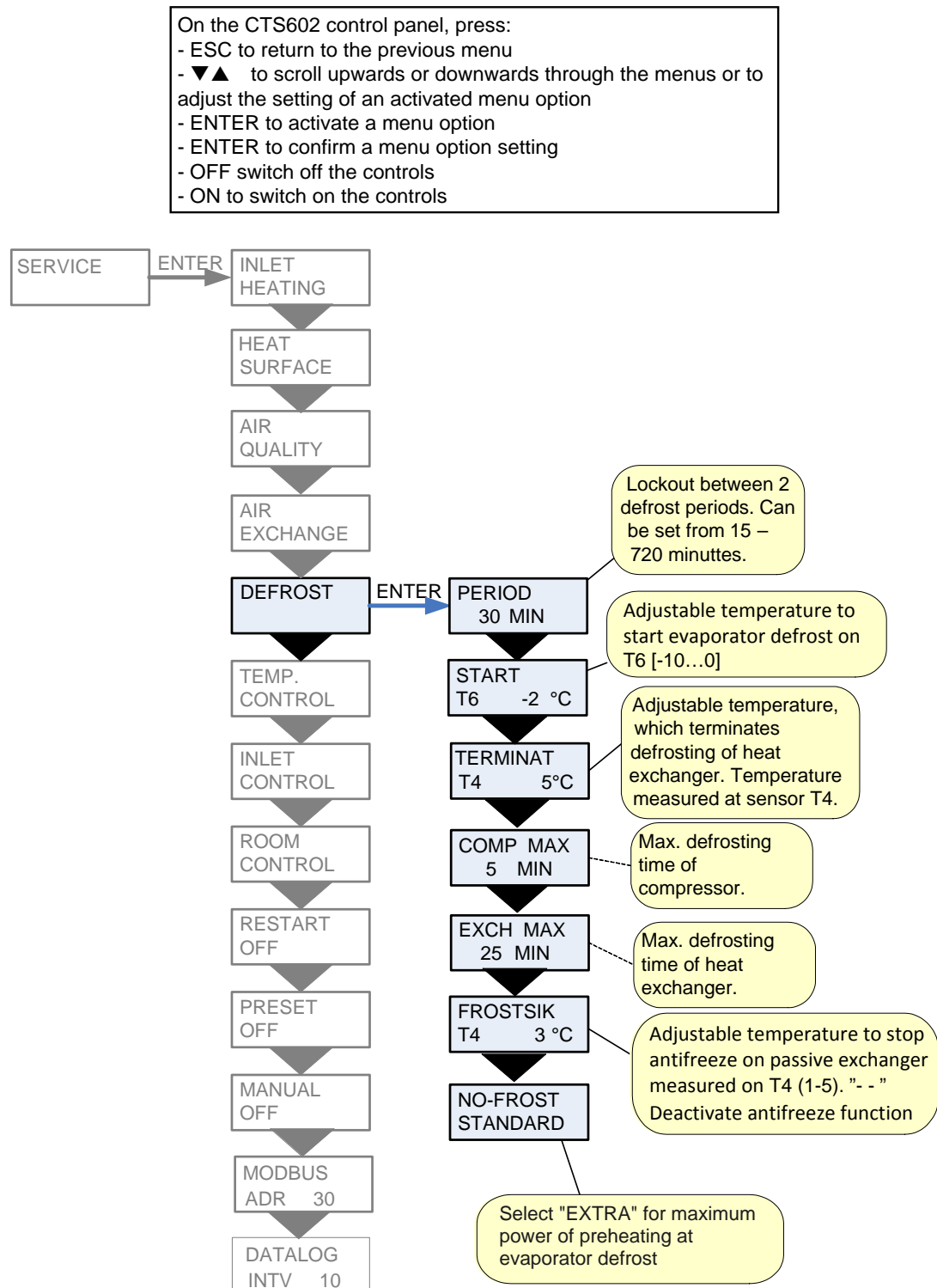

Figure 11: The "Defrost" Menu

Temp. control

The temperature sensor to be used to control the system is selected in the TEMP. CONTROL menu. It is also possible to stipulate a minimum temperature at which the system is to be stopped to prevent further cooling of the building if the primary heating system has cut out for some reason.

Options that flash are indicated by " "

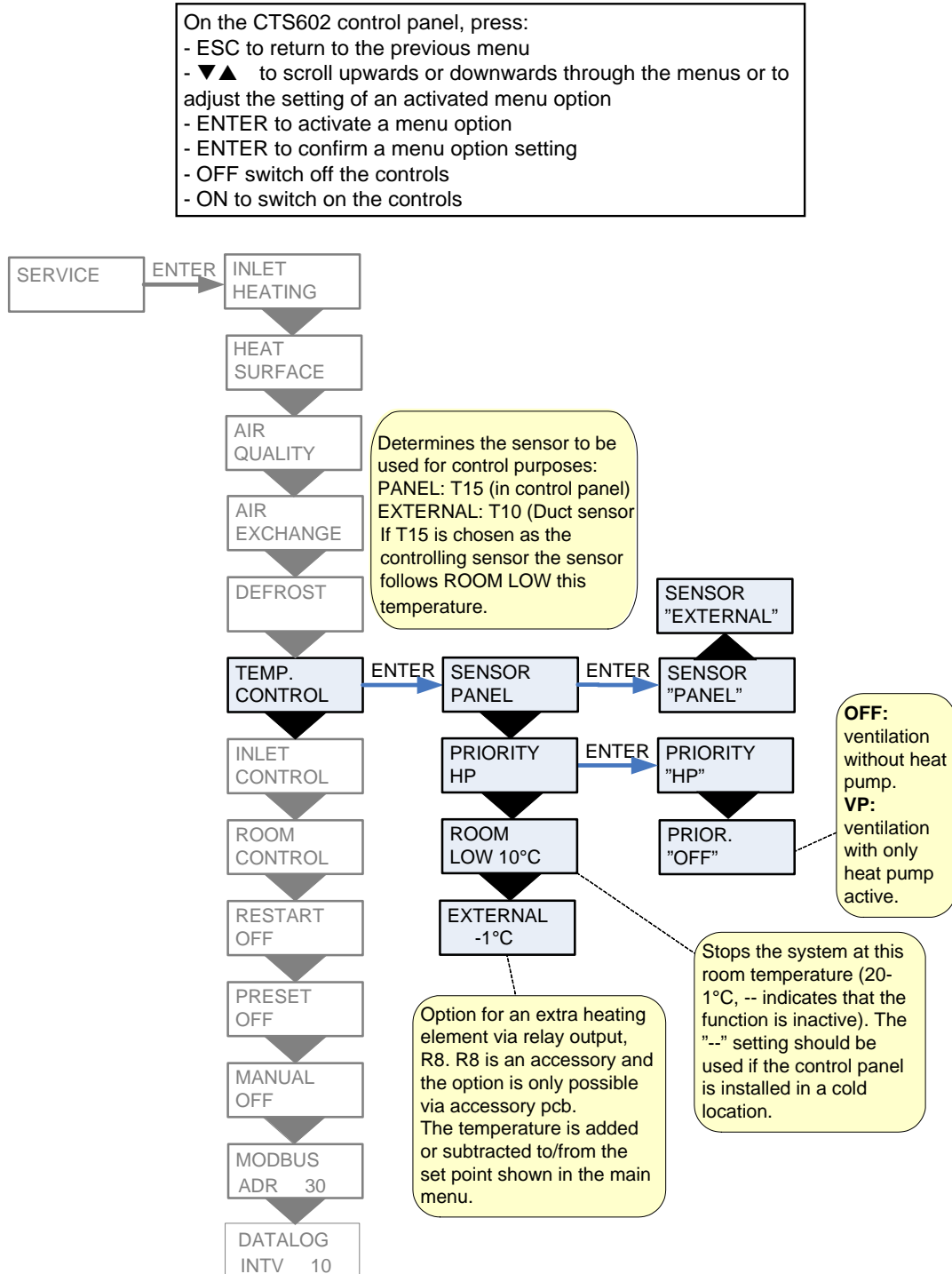

Figure 12: The "Temp. control" Menu

Inlet control

The inlet control menu makes it possible to set the time in which the compressor has to be shut off before restart.



Parameters in the INLET CONTROL menu should only be set by experienced control technicians.

On the CTS602 control panel, press:

- ESC to return to the previous menu
- ▼▲ to scroll upwards or downwards through the menus or to adjust the setting of an activated menu option
- ENTER to activate a menu option
- ENTER to confirm a menu option setting
- OFF switch off the controls
- ON to switch on the controls

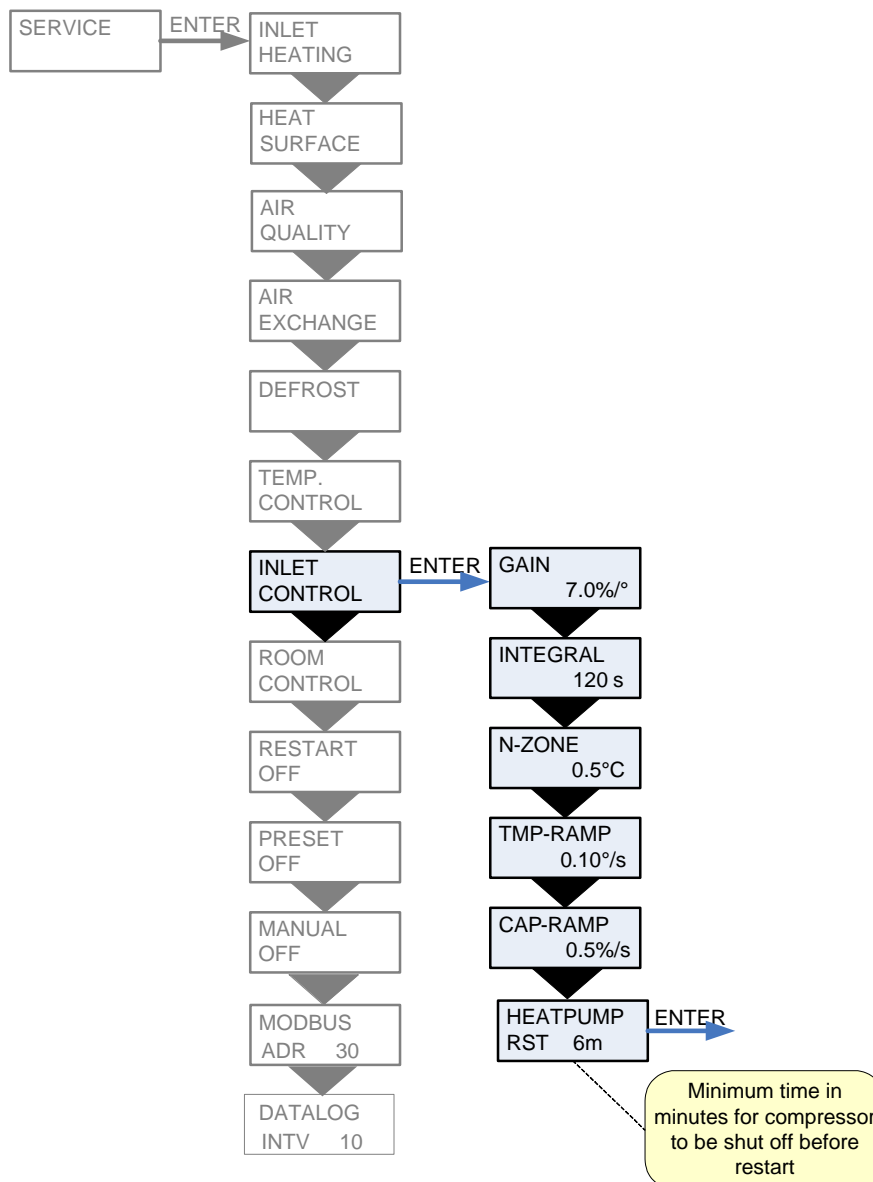

Figure 13: The "Inlet control" Menu

Room control

The ROOM CONTROL menu allows the room temperature controller to be set.

Options that flash are indicated by " "



Parameters in the ROOM CONTROL menu should only be set by experienced control technicians.

On the CTS602 control panel, press:

- ESC to return to the previous menu
- ▼▲ to scroll upwards or downwards through the menus or to adjust the setting of an activated menu option
- ENTER to activate a menu option
- ENTER to confirm a menu option setting
- OFF switch off the controls
- ON to switch on the controls

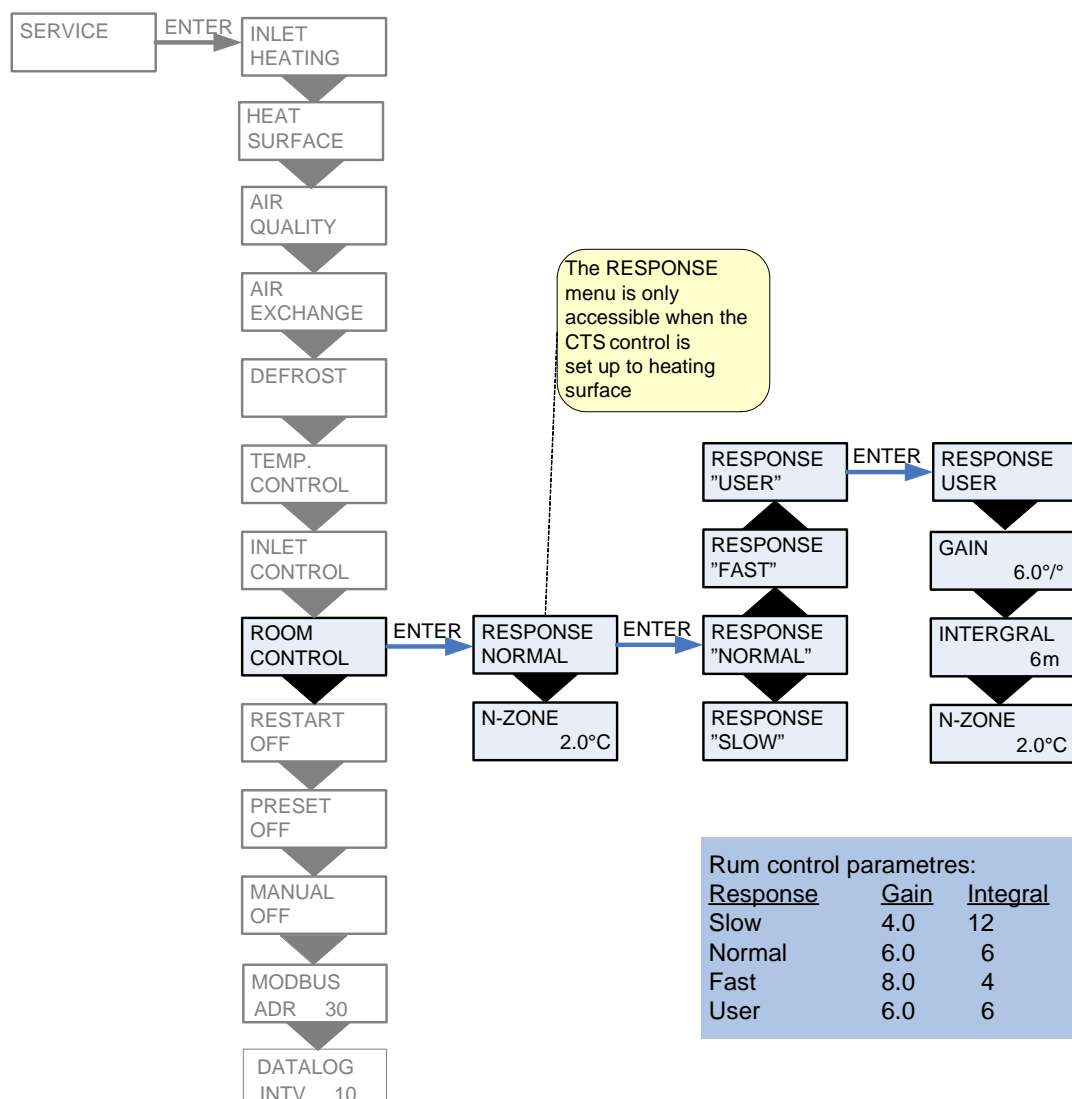

Figure 14: The "Room control" Menu

Restart

The RESTART menu allows the system to be set to restart automatically in connection with high or low pressure faults.

Fire alarms can be acknowledged automatically in connection with fire drills/testing. A condition for acknowledgement is that the fire thermostat input has returned to normal state.

Options that flash are indicated by " "



The "HP/LP" setting in the RESTART menu must not be used during normal operation.

On the CTS602 control panel, press:

- ESC to return to the previous menu
- ▼▲ to scroll upwards or downwards through the menus or to adjust the setting of an activated menu option
- ENTER to activate a menu option
- ENTER to confirm a menu option setting
- OFF switch off the controls
- ON to switch on the controls

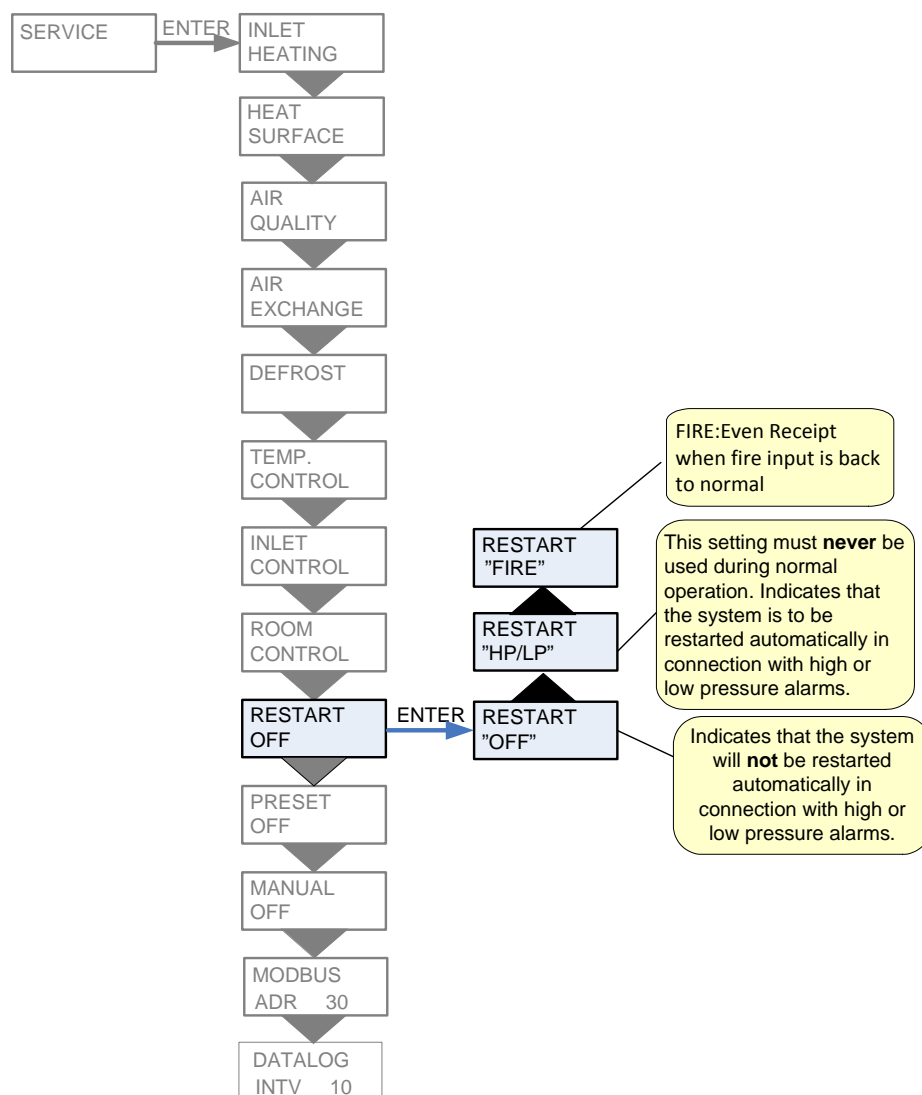

Figure 15: The "Restart" Menu

Preset

The PRESET menu allows default factory settings to be stored.

RESTORE menu allows you to reload a copy of the installation setup.

By keeping the ESC + key pressed for 5 seconds a new menu item RESTORE appear, this is then acceptable / activated by pressing the ENTER

Options that flash are indicated by " "

On the CTS602 control panel, press:

- ESC to return to the previous menu
- ▼▲ to scroll upwards or downwards through the menus or to adjust the setting of an activated menu option
- ENTER to activate a menu option
- ENTER to confirm a menu option setting
- OFF switch off the controls
- ON to switch on the controls

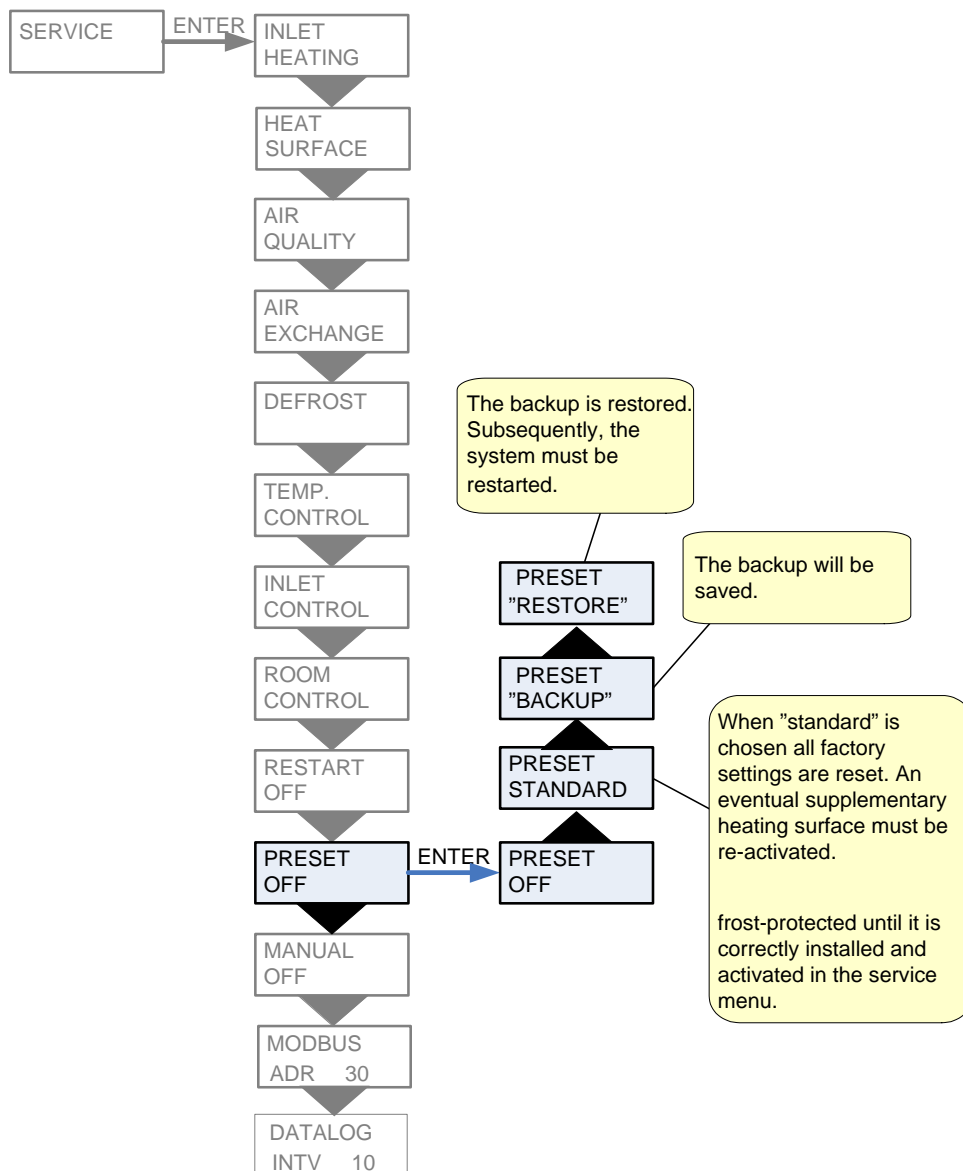

Figure 16: The "Preset" Menu

Manual

The MANUAL menu allows system functions to be tested manually.

Options that flash are indicated by " "

On the CTS602 control panel, press:

- ESC to return to the previous menu
- ▼▲ to scroll upwards or downwards through the menus or to adjust the setting of an activated menu option
- ENTER to activate a menu option
- ENTER to confirm a menu option setting
- OFF switch off the controls
- ON to switch on the controls

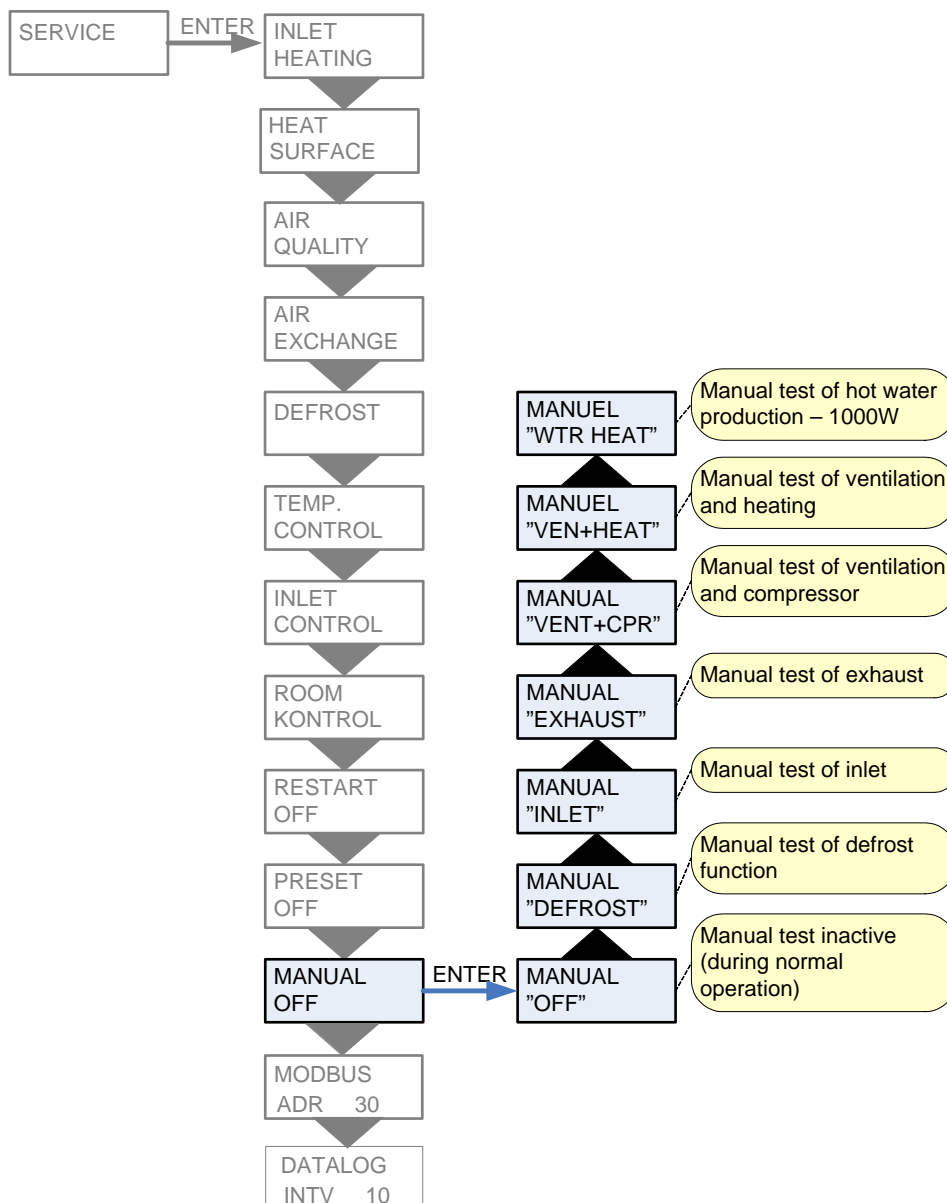

Figure 17: The "Manual" Menu

Modbus

Options that flash are indicated by " "

On the CTS602 control panel, press:

- ESC to return to the previous menu
- ▼▲ to scroll upwards or downwards through the menus or to adjust the setting of an activated menu option
- ENTER to activate a menu option
- ENTER to confirm a menu option setting
- OFF switch off the controls
- ON to switch on the controls

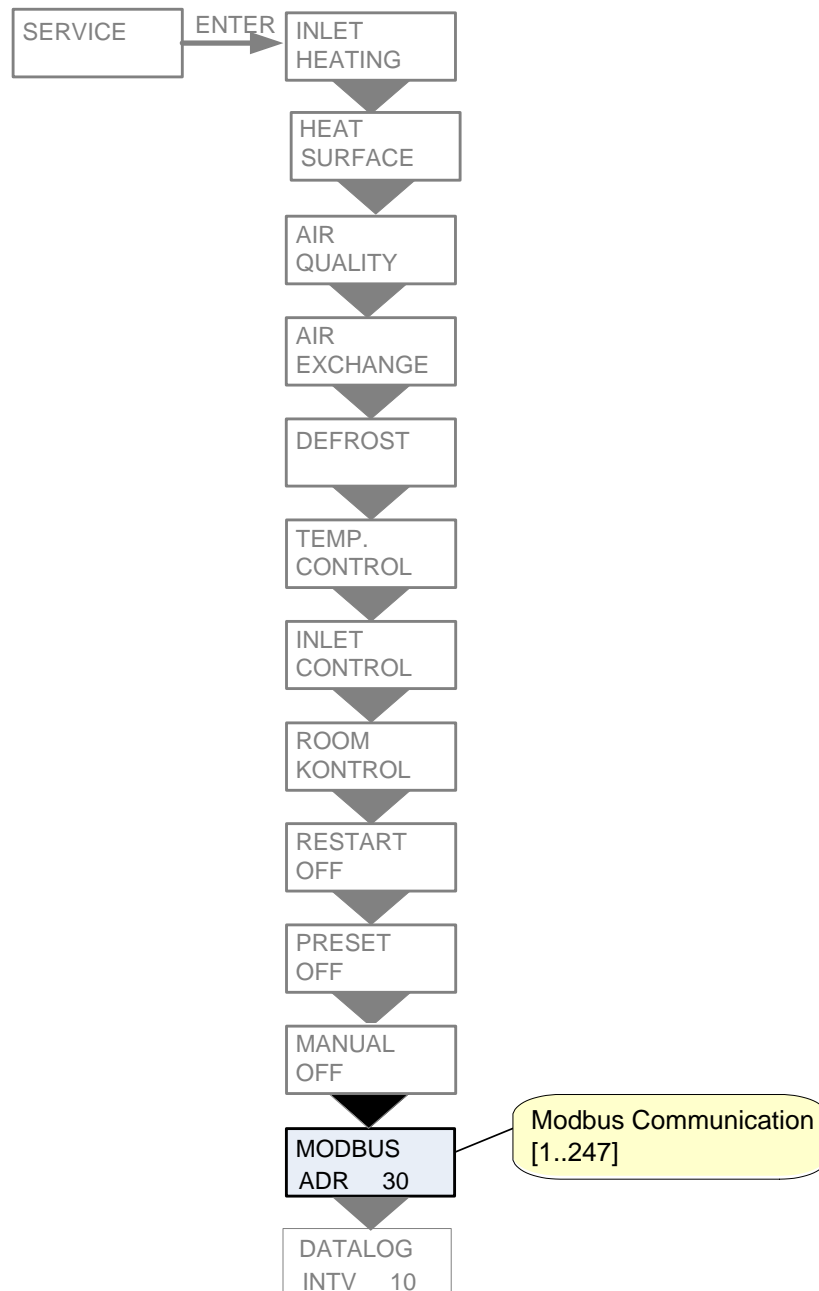

Figure 18: The "Modbus" Menu

Datalog

The datalog interval is set via the menu SERVICE - DATALOG INTV at between 1 and 120 minutes.

If 0 / OFF is selected, logging is not periodical, but only on events and alarms.

- Temperatures are logged in Celsius, in whole degrees, in order to minimise the log file size.
- The status of digital inputs and outputs is combined in two shared log variables: "Din" and "Dout".

Options that flash are indicated by " "

On the CTS602 control panel, press:

- ESC to return to the previous menu
- ▼▲ to scroll upwards or downwards through the menus or to adjust the setting of an activated menu option
- ENTER to activate a menu option
- ENTER to confirm a menu option setting
- OFF switch off the controls
- ON to switch on the controls

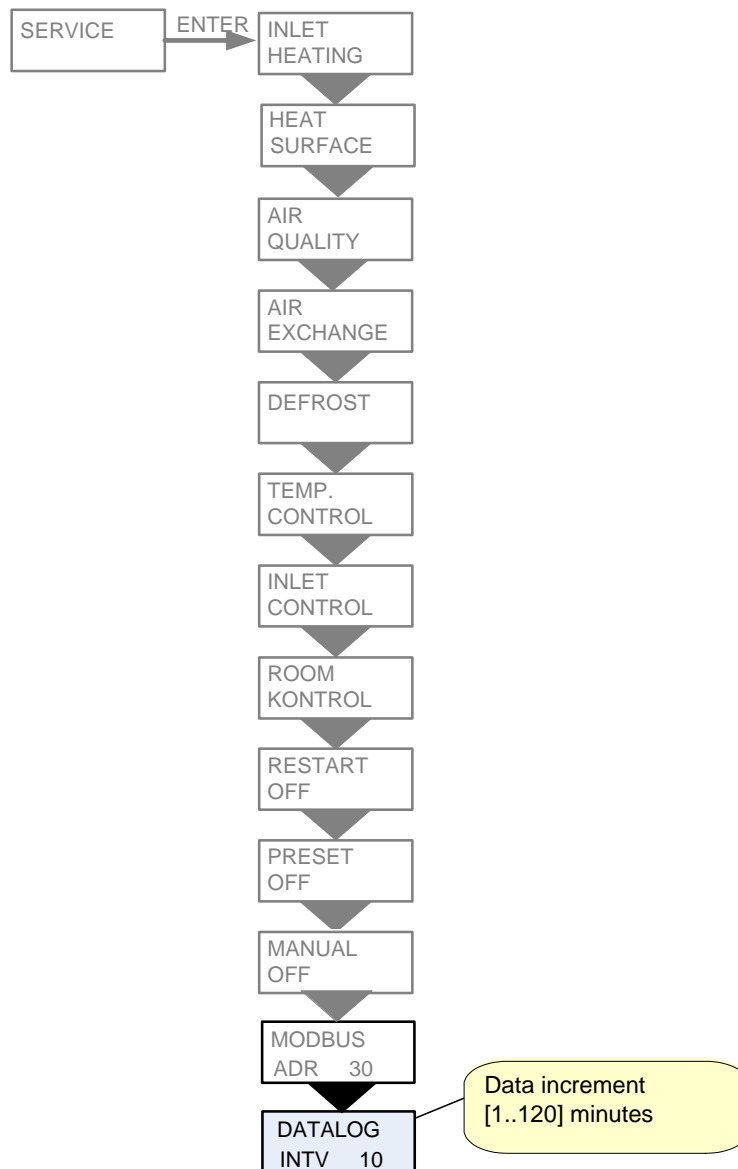
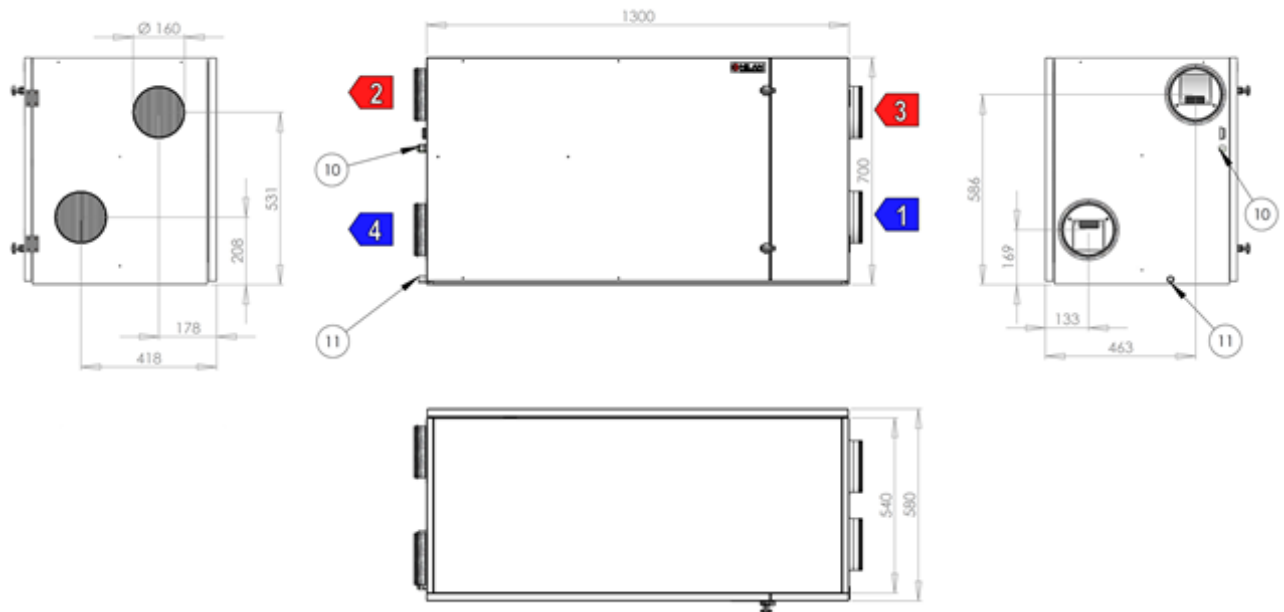

Figure 19: The "Datalog" Menu

System dimension



Combi 302 Polar

- 1 : Aussenluft
- 2 : Zuluft
- 3 : Abluft
- 4 : Fortluft
- 10 : Stromversorgung
- 11 : Kondens Ablauf

Figure 20: System dimension

Accessories / spare parts

Combi 302 Polar		
Filter types	Qty.	Nilan item no.
Filter sheet G4, 8 pcs.	1	391713
Filter cassette F7	1	39520